

CE

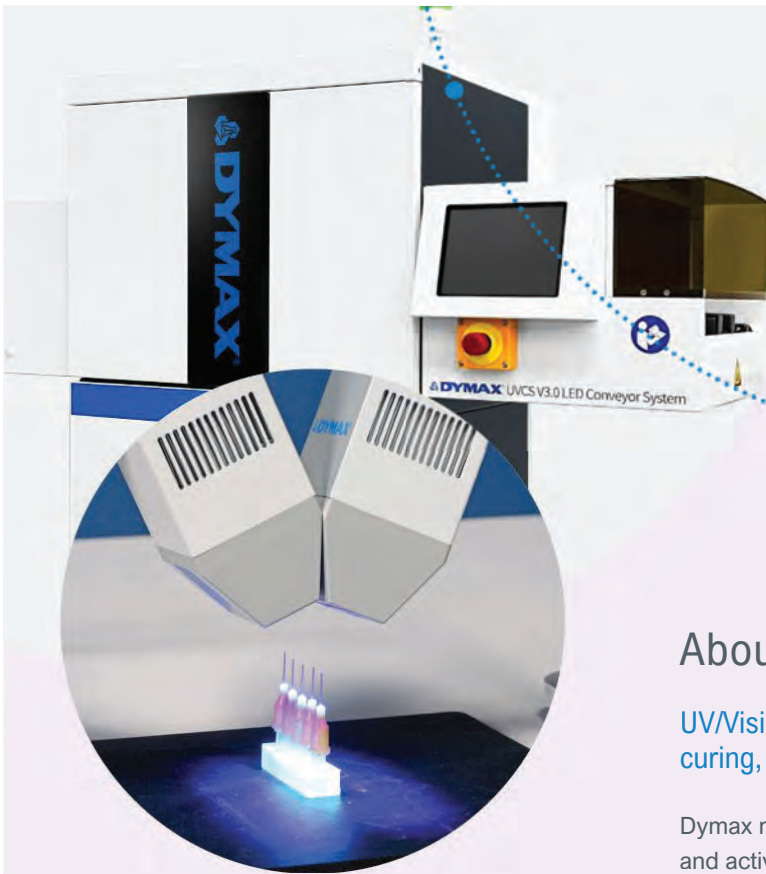

UVCS V3.0 LED

Light-Curing Conveyor
User Guide
REV 1.0



About Dymax

UV/Visible light-curable adhesives. Systems for light curing, fluid dispensing, and fluid packaging.

Dymax manufactures industrial, light-curable, epoxy, and activator-cured adhesives. We also manufacture a complete line of manual fluid dispensing systems, automatic fluid dispensing systems, and light-curing systems. Light-curing systems include LED light sources, spot, flood, and conveyor systems designed for compatibility and high performance with Dymax adhesives.

Dymax adhesives and light-curing systems optimize the speed of automated assembly, allow for 100% in-line inspection, and increase throughput. System designs enable stand-alone configuration or integration into your existing assembly line.

Please note that most dispensing and curing system applications are unique. Dymax does not warrant the fitness of the product for the intended application. Any warranty applicable to the product, its application, and use is strictly limited to that contained in the Dymax standard Conditions of Sale. Dymax recommends that any intended application be evaluated and tested by the user to ensure that desired performance criteria are satisfied. Dymax is willing to assist users in their performance testing and evaluation by offering equipment trial rental and leasing programs to assist in such testing and evaluations. Data sheets are available for valve controllers or pressure pots upon request.

Contents

Introduction	4
Where to Get Help.....	4
Safety	4
Product Overview	5
Unpacking	6
Unpacking and Inspecting Your Shipment.....	6
Parts Included	6
Conveyor Main Components.....	7
System Features & Benefits	9
System Installation	10
Assemble the Conveyor and Cabinet Together.....	10
Input Power	11
Belt Tracking Adjustment.....	11
Shading Curtain Height Adjustment	12
Edge-Carry Width Adjustment	12
Adding the Emitters and Controllers to the Conveyor	12
Wiring and Connections.....	16
Turn On.....	18
Emergency Stop	19
Operation	20
System Flow Chart	20
Start Up.....	20
System Settings	21
Brightness.....	22
Clock and Calendar Settings.....	23
Input the Password	23
Changing the Password.....	23
System Reset	23
Main Window Settings.....	24
Select Conveyor Mode	26
Set Moving Mode Parameters.....	26
Set Static Mode Parameters	27
Setting the Emitter Location	27
Speed of Static Mode.....	28
Program Settings	28
System Log.....	29
PLC Mode	32
PLC UV Control.....	32
Maintenance	35
Routine Maintenance.....	35
Spare Parts & Accessories	36
Accessories	36
Components & Spare Parts.....	37
Product Specifications	38
Declaration of Conformity	39
Validation	41
Set Exposure Time, Determine Intensity.....	41
Set Intensity, Determine Exposure Time.....	41
Control	41
Warranty	42

Introduction

This guide describes how to set up, use, and maintain the UVCS V3.0 LED system safely and efficiently. Before using this product, please be sure to read the instruction manual carefully and ensure it properly.

Intended Audience

This user guide is meant for experienced process engineers, technicians, and manufacturing personnel. If you are new to high-intensity LED light sources and do not understand the instructions, contact Dymax Application Engineering for answers to your questions before using the equipment.

Where to Get Help

Dymax Customer Support and Application Engineering teams are available by phone and email in the United States, Monday through Friday, from 8:00 a.m. to 5:30 p.m. Eastern Standard Time, and in Germany, Monday through Friday, from 8:00 a.m. to 5:00 p.m. Central European Time. You can also email Dymax at info@dymax.com or Dymax Europe GmbH at info_de@dymax.com. Contact information for additional Dymax locations can be found on the back cover of this user guide.

Additional resources are available to ensure a trouble-free experience with our products:

- Detailed product information on our website www.dymax.com & www.dymax.de
- Dymax adhesive product data sheets on our website
- Safety data sheets (SDS) provided with shipments of Dymax materials

Safety



WARNING! *If you use this UV light source without first reading and understanding the information in the UV Light Safety Guide, SAF001, injury can result from exposure to high-intensity light. To reduce the risk of injury, please read and ensure you understand the information in that guide before assembling and operating the Dymax UV LED light source.*

This device falls under IEC 62471 Risk Group 3 for UVA and Blue Light emissions:

WARNING! *UV emitted from this product. Avoid eye and skin exposure to unshielded products.*

WARNING! *Possibly hazardous optical radiation emitted from this product. Do not look at operating lamp. Eye injury may result.*

Product Overview

The UVCS V3.0 LED is a modernized conveyor platform designed to operate with Dymax's latest high-power LED flood emitters. It combines a new industrial design with the latest features in curing system technology, providing ease of use and the highest quality of life for operators.

Each facet of the design was curated to maximize and enhance operations. It improves monitoring and facilitates control of the curing process directly from the conveyor by incorporating speed control, automatic part sensing, and control of the installed emitters. Additionally, the UVCS V3.0 LED was carefully developed for easy integration into larger manufacturing systems and processes.

The UVCS V3.0 is ideally suited for a number of applications in the medical, consumer electronics, automotive, aerospace and defense, optical, and appliance industries. It is the ideal solution for LED curing in high throughput manufacturing processes.

Unpacking

Unpacking and Inspecting Your Shipment

Upon arrival, inspect all boxes for damage and notify the shipper of box damage immediately. Open each box and check for equipment damage. If parts are damaged, notify the shipper and submit a claim for the damaged parts. Contact Dymax so that new parts can be shipped to you immediately.

The parts below are included in every package/order. If parts are missing from your order, contact your local Dymax representative or Dymax Customer Support to resolve the problem.

Note: After inspecting the package, use a socket tool to remove the screws around and above the wooden package. The screws are reusable. It is necessary to install the Alarm Lamp on the conveyor according to the figure. If the exhaust pipe is to be installed, install it to the outlet of the exhaust fan according to the figure, and secure it with four screws.

Parts Included

- **UVCS V3.0 Conveyor (Base)**
PN: 88870 UVCS V3.0 BELT 220V
PN: 88871 UVCS V3.0 BELT 110V
PN: 88878 UVCS V3.0 EDGE 220V
PN: 88879 UVCS V3.0 EDGE 110V
- **Cradle (mounted in unit, included in sales PN)**
PN: 80021 FX1250 CRADLE, HA, UVCS V3.0
PN: 80022 FX1250 CRADLE, VA, UVCS V3.0
- **Power Cord**
PN: 84301 AC CORD, CN PLUG, UVCS
PN: 84302 AC CORD, NA PLUG, UVCS
PN: 84303 AC CORD, EU PLUG, UVCS
PN: 84304 AC CORD, UK PLUG, UVCS
- **Exhaust Pipe**
PN: 82131 PIPE, EXHAUST
PN: 83864 GB/T 818 M4×6
- **UVCS V3.0 LED Conveyor System User Guide**
PN: 87072 USER MANUAL, UVCS V3.0
- **UV GOGGLES**
PN: 84126 UV GOGGLES

Figure 1.
UVCS V3.0 LED Conveyor Packaging

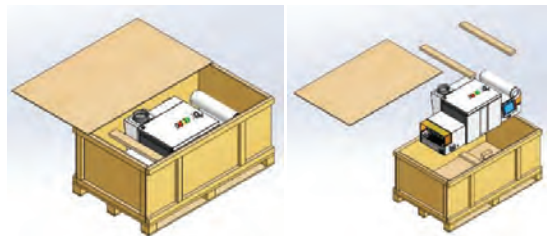

Install the Exhaust Pipe and the Alarm Lamp

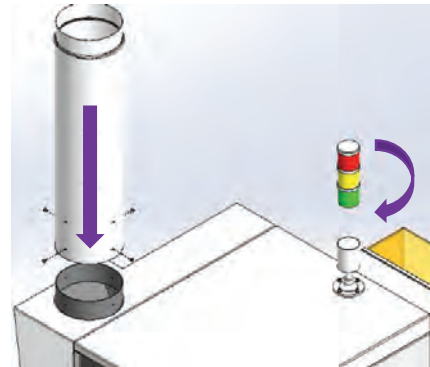
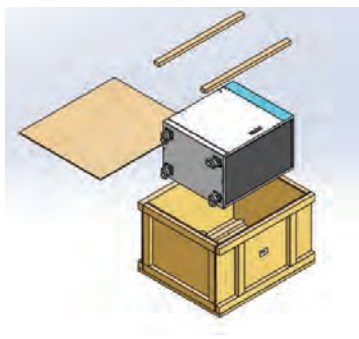
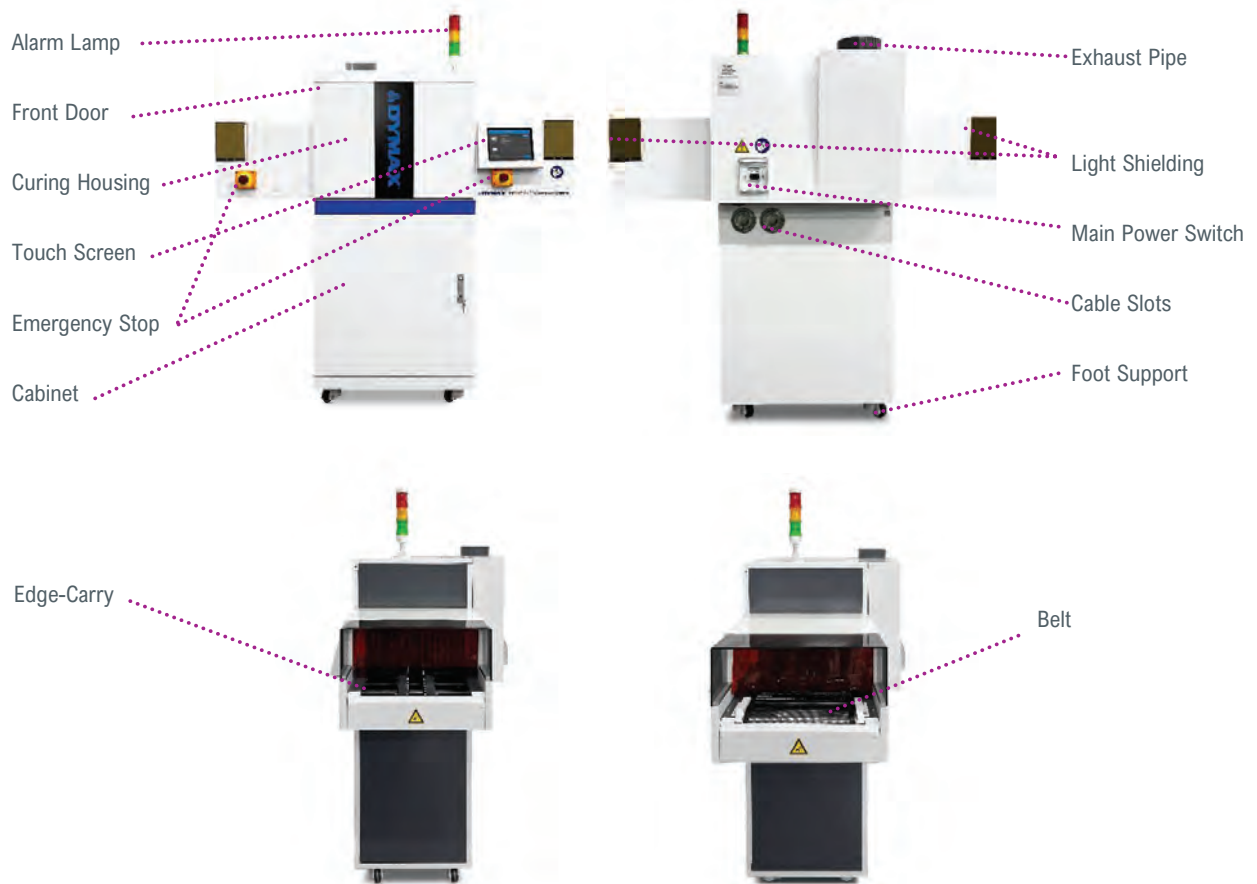

Figure 2.
Cabinet Accessory Packaging (PN: 80020); Sold Separately













Conveyor Main Components

- **Touch Screen:** 8" HMI touch screen
- **Curing Housing:** Includes adjustable lamp bracket and thermal exhaust system
- **Front Door:** Provides access to emitter cradle. Logo illuminates when emitter is on
- **Emergency Stops:** Press down any one of the Emergency Stop in case of emergency to power off the conveyor. Rotate clockwise to reset and power on
- **Light Shielding:** Removable shielding for UV-light
- **Belt:** UV-resistant belt; belt speed is adjustable from 0.4~7.8m/min
- **Edge-Carry:** Edge-width can be adjusted from 38mm (1.5 inches) to 255 mm (10 inches)
- **Cabinet:** Purchasable accessory used to mount conveyor and to store controller inside
- **Exhaust Pipe:** Exhausts thermal air from curing housing inside; diameter = 150 mm (6 inches)
- **Alarm Lamp:** A green light means the conveyor is working normally; a red light is accompanied by an alarm sound and indicates a conveyor breakdown; a yellow light means the conveyor is in waiting state.

Table 1.
Labels

<p>Warning Labels</p>	 <p>When the equipment is in operation, do not touch the electrical cabinet to avoid injury from electric shocks.</p>  <p>When the equipment is in operation, do not touch the roller, the conveyor belt or the chain to prevent mechanical damage.</p>
<p>Product Information Label</p>	<div style="display: flex; flex-wrap: wrap; justify-content: space-around;"> <div style="border: 1px solid black; border-radius: 10px; padding: 10px; width: 45%;">  <p>UVCS V3.0 LED Conveyor System Model : 110V Belt Current : 3A Input : 90-125VAC,50/60Hz Loading : 25kg Max Speed : 7.8m/min Max</p> <p style="text-align: right;">CE UK CA</p> <hr/> <p style="font-size: 8px;">Manufacturer: Hanarey Chemicals (Shanghai) Co., Ltd. No. 111 Muhua Road, Fengxian District, Shanghai, China 201507</p> </div> <div style="border: 1px solid black; border-radius: 10px; padding: 10px; width: 45%;">  <p>UVCS V3.0 LED Conveyor System Model : 220V Belt Current : 1.5A Input : 196-264VAC,50/60Hz Loading : 25kg Max Speed : 7.8m/min Max</p> <p style="text-align: right;">CE UK CA</p> <hr/> <p style="font-size: 8px;">Manufacturer: Hanarey Chemicals (Shanghai) Co., Ltd. No. 111 Muhua Road, Fengxian District, Shanghai, China 201507</p> </div> <div style="border: 1px solid black; border-radius: 10px; padding: 10px; width: 45%;">  <p>UVCS V3.0 LED Conveyor System Model : 110V Edge Current : 3A Input : 90-125VAC,50/60Hz Loading : 25kg Max Speed : 7.8m/min Max</p> <p style="text-align: right;">CE UK CA</p> <hr/> <p style="font-size: 8px;">Manufacturer: Hanarey Chemicals (Shanghai) Co., Ltd. No. 111 Muhua Road, Fengxian District, Shanghai, China 201507</p> </div> <div style="border: 1px solid black; border-radius: 10px; padding: 10px; width: 45%;">  <p>UVCS V3.0 LED Conveyor System Model : 220V Edge Current : 1.5A Input : 196-264VAC,50/60Hz Loading : 25kg Max Speed : 7.8m/min Max</p> <p style="text-align: right;">CE UK CA</p> <hr/> <p style="font-size: 8px;">Manufacturer: Hanarey Chemicals (Shanghai) Co., Ltd. No. 111 Muhua Road, Fengxian District, Shanghai, China 201507</p> </div> </div>
<p>High Temperature Caution Label</p>	 <p>When the equipment is in operation, do not touch the equipment or get close to the exhaust vent to avoid high-temperature injury.</p>
<p>Instruction Reading Label</p>	 <p>Read the User Manual before using and operating the equipment.</p>

System Features & Benefits



1 High-Contrast Touch Screen HMI

- 8" touch screen
- Easy-to-use modern UI
- Includes storage and programming modes
- Controls lamps and emitters



2 Multiple Operation Modes

- Manual static mode to use conveyor as cure oven
- Manual moving for conveyor operations
- PLC mode with multichannel I/O for remote operation in large processes



3 Part Sensing and Speed Control

- Accurate and precise control
- Eliminates risk of over or under curing
- Parts stay safely on belt when conveyor isn't operating

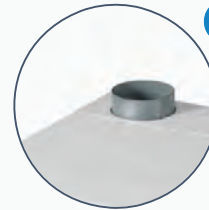

4 High-Power Exhaust System

- Keeps chamber cool for temperature-sensitive parts
- Keeps heat out of the room



5 Fully Enclosed Lamp Installation

- Minimizes noise
- Reduces heat generation



6 Uses BlueWave® FX-1250 Emitters

- High-power LED lamps
- Instant on-off with no warm-up period
- More energy efficient

System Installation

Assemble the Conveyor and Cabinet Together

- 1) Raise the foot supports by rotating them and placing the rollers on the ground for easy movement. (Figure 3.)
- 2) Lift the conveyor onto the cabinet by inserting the 4 rubber bumpers into the holes on the top of cabinet. (Figure 4.)

Note: After assembly, complete the ground connection according to Figure 33.

- 3) When the conveyor is being moved or assembled, the position of the load on the equipment is shown in (Figure 6.).
- 4) Insert the communication/power/drive cord into cabinet thread holes. (Figure 5.)
- 5) Revise the height level by adjusting the bottom foot supports.

Figure 3.
Raise the Foot Support



Figure 4.
Insert 4 Bumpers of the Conveyor into the Top of the Cabinet

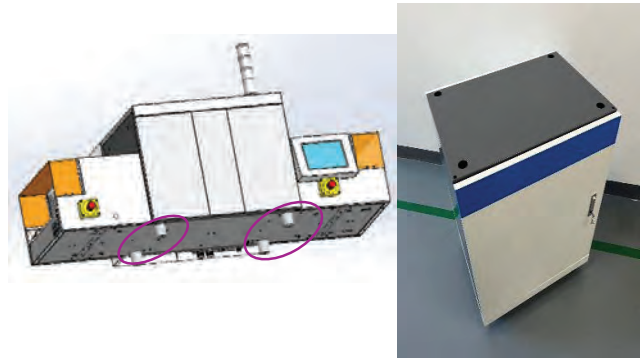

Figure 5.
Cable Slots on Cabinet

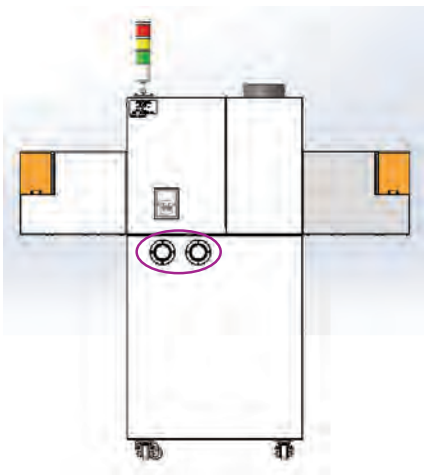

Figure 6.
Load Position



Input Power

The input power of the conveyor is shown in the following table. (Table 2)

Table 2.

Input Power

Voltage Range	Max Current	Input Power Frequency
AC 90~125V	3A	50/60HZ
AC 196~264V	1.5A	50/60HZ

Note: The curing units and the conveyor unit have separate electrical circuits. Before commissioning, make sure that your main connection is designed for the maximum power requirement of the conveyor. Connect all power cords directly and do not use external power strips. When using a conveyor with two curing systems, be sure to plug the second unit into a separately fused outlet to prevent circuit overload.

Belt Tracking Adjustment

The conveyor is factory adjusted to provide proper tracking of the belt. If further adjustments are necessary:

Figure 7.

White Rubber Hole Plug on the Sealing Plate



Figure 8.

Tension Screws at the Input End Side

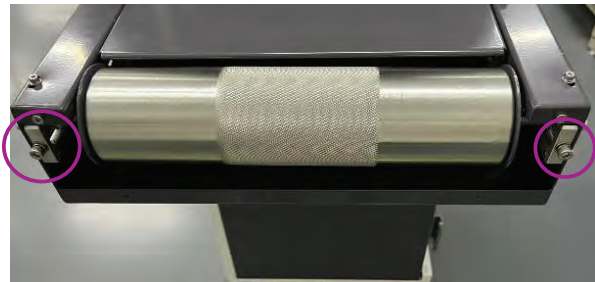

Figure 9.

The Belt or Edge Positive Direction



Figure 10.

Remove or Coat the Quick Drying Glue at Both Ends of the Shaft of the Belt Joint

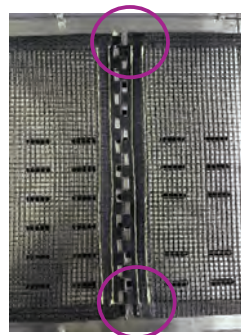

- 1) Remove the white rubber hole plug from the sealing plate on the left side of the conveyor. (Figure 7.)
- 2) There are two tension screws located at the input end of the conveyor. To adjust tracking, simply tighten the side to which the belt is tracking through the hole (Figure 8.)

Note: When changing the direction of rotation for the belt conveyor, the position of the belt must be adjusted to prevent the belt deviation. When the user faces the conveyor screen, the clockwise rotation of the belt or edge defaults to the positive direction. (Figure 8.) When the belt needs to be removed or installed, the quick drying glue at both ends of the shaft of the belt joint needs to be removed or coated. (Figure 10.)

Shading Curtain Height Adjustment

The height of the shading curtains can be adjusted by loosening two screws as shown. (Figure 11.) The lowest height of the shading curtain from the belt surface is 11.5 mm and from the edge surface is 18mm. The shading curtains are designed to protect the operators from UV, so it is suggested to not remove the curtain, or raise it too high to block UV light.

Figure 11.

Shading Curtains Height Adjustment

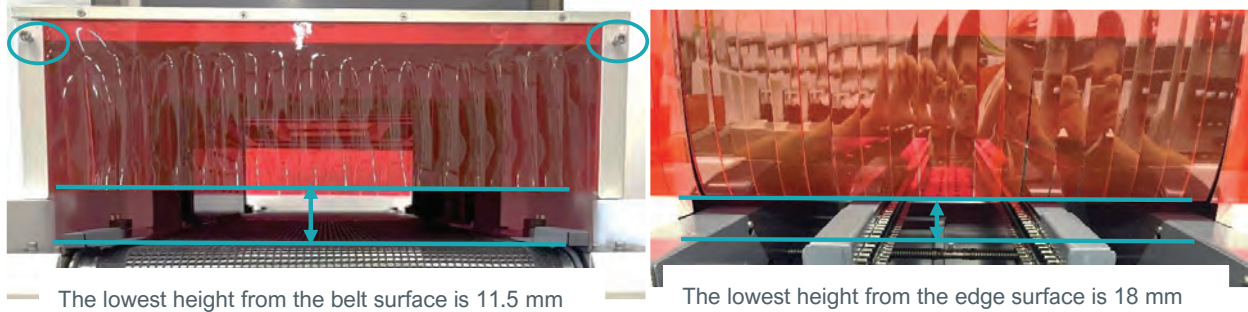

Edge-Carry Width Adjustment

The width of the Edge-Carry conveyor can be adjusted from the front side through the handwheel. The adjustment range is from 38 mm to 255 mm, the width is reduced by clockwise rotation and is increased by counterclockwise rotation. (Figure 12.)

Figure 12.

Edge-Carry Width Adjustment

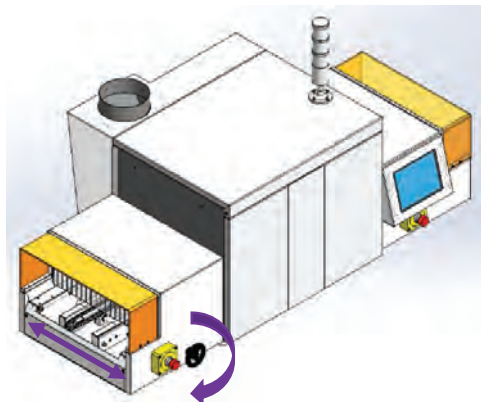

Adding the Emitters and Controllers to the Conveyor

- 1) Remove the back panel (Figure 13. - Figure 15.) and the upper cover of the conveyor, (Figure 16.) install the support modules and the brace hook (Figure 17.). Adjust the emitter cradle height using the four locking handles (Figure 18.). The lowest height is 12 mm from the emitter cradle's bottom to the belt surface.
- 2) Put the four screws on the emitter holder into the four round holes on the cradle. The slotted side of the light frame should face the exhaust fan. (Figure 19.)
- 3) Place the emitters on the cradle. (Figure 20.) The arrangements of the emitters are shown (Figure 21.) (Figure 22.). For 1x1, 1x2 horizontal, and 2x1 vertical configurations, **it is advised to place the emitters on the side closest to the exhaust fan.**
- 4) Complete wiring as required. (Figure 23. - Figure 27.)
- 5) When adding the controllers to the cabinet, open the front door of the cabinet as shown (Figure 28.).

Note: When adjusting the curing height, the cradle and emitters should be removed from the bracket first.

Figure 13.
Loosen Four Screws Under the Back Panel

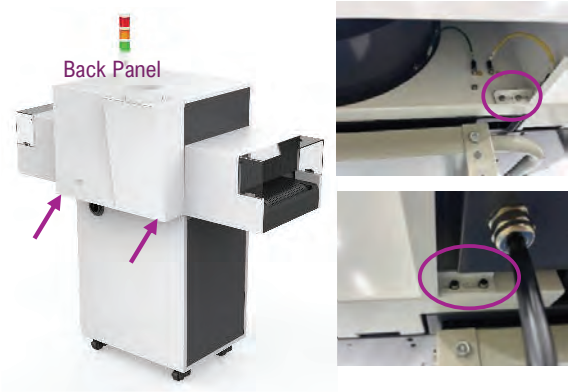

Figure 14.
Remove the Grounding Wire inside the Back Panel at the Position as Shown

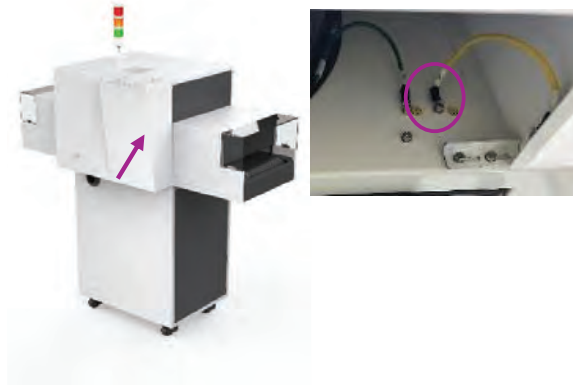

Figure 15.
Remove the Back Panel



Figure 16.
Open the Upper Cover



Figure 17.
Install the Support Modules and the Brace Hook

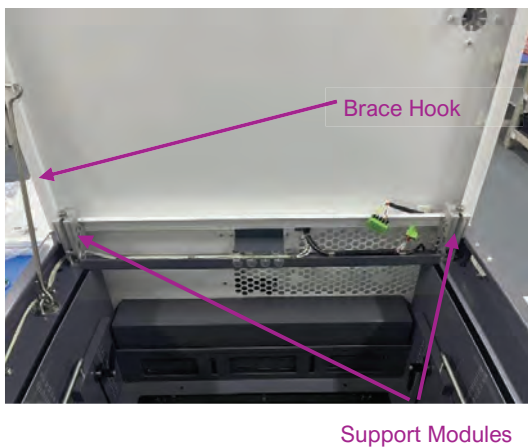

Figure 18.
Four Locking Handles

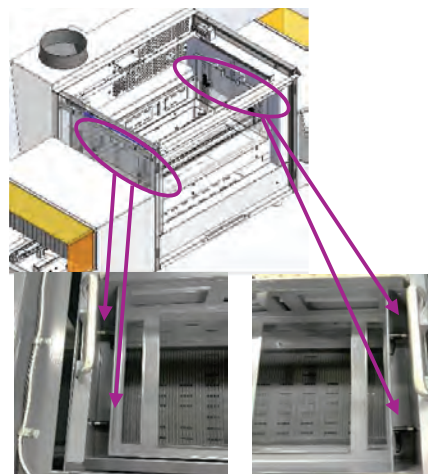

Figure 19.
Four Screws on Lamp Holder

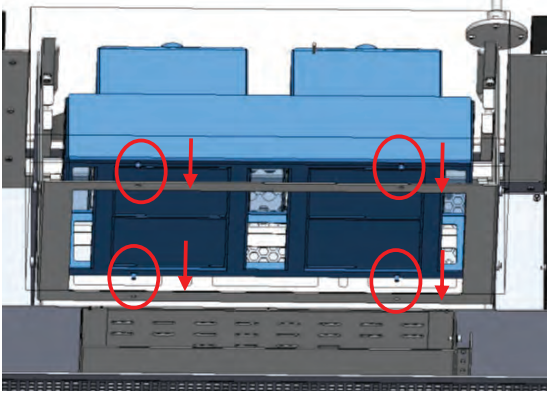

Figure 20.
Place the Emitters on a Cradle

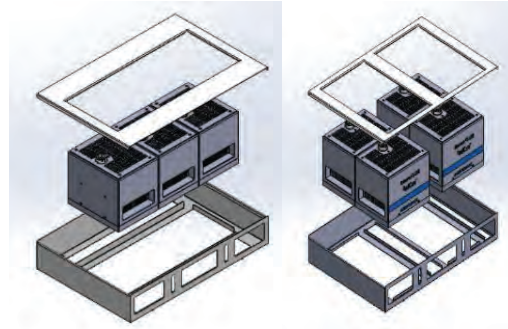

Figure 21.
Horizontal Configuration PN:80021

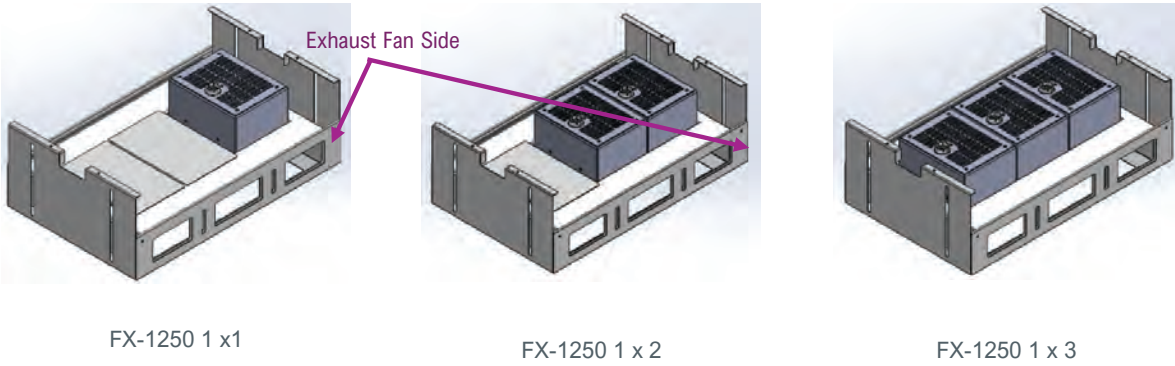

Figure 22.
Vertical Configuration PN:80022

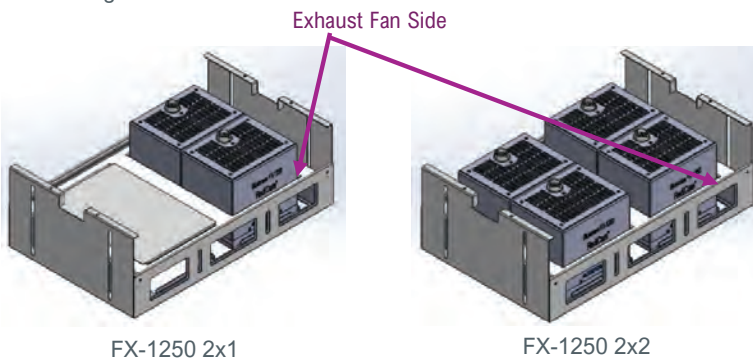

Figure 23.
Loosen the Screws, remove the Wire Pressing Plate



Figure 24.
Cable Connector goes through the Wire Slot



Figure 25.
Install Connector on the Emitter Connection Port

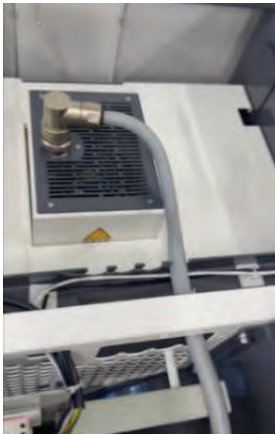

Figure 26.
Install the Wire Pressing Plate, and add the Screws



Figure 27.
Install Connector and Network Wire on the Controller Connection Port



Remove the lids of the Cable Slots

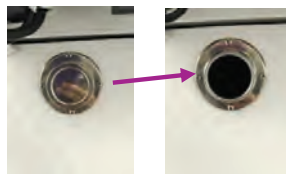

The Connector and the Network Wire go through the Cable Slots



Install Connector and Network Wire on the Controller Connection



Figure 28.

Open the Front Door of the Cabinet

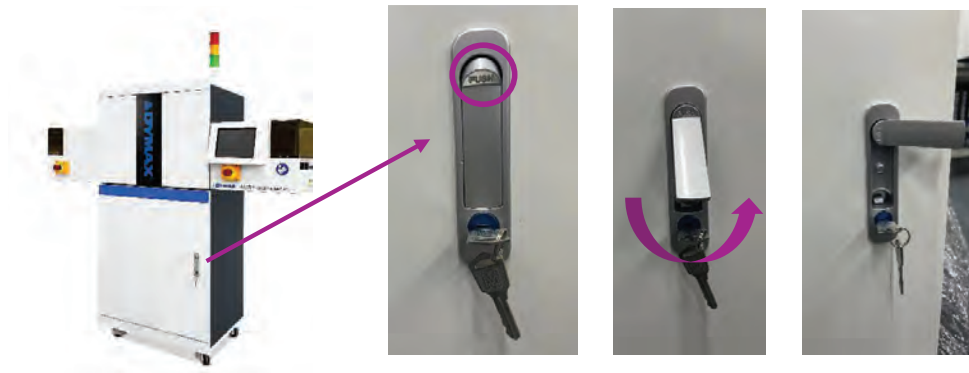

Wiring and Connections

- 1) The conveyor will be provided with a region-specific 220VAC/110VAC power plug, as shown in Figure 29., Figure 30., Figure 31., Figure 32.

Figure 29.
Power Cord with
TYPE-I CN Plug

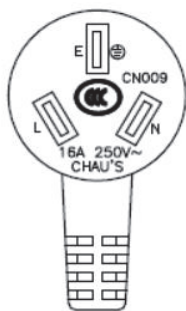

Figure 30.
Power Cord with TYPE-B NA Plug

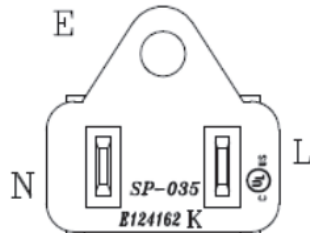

Figure 31.
Power Cord with TYPE-F EU
Plug

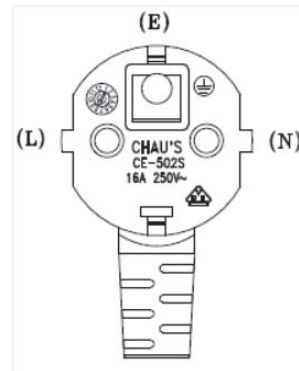
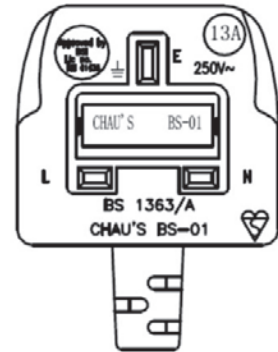

Figure 32.
Power Cord with TYPE-G UK
Plug



- 2) The conveyor may be grounded by using the reserve grounding wire. (Figure 33.)
If the cabinet is in use, the grounding wire can be connected to the grounding column in the cabinet. (Figure 34.)

Figure 33.
Grounding Wire

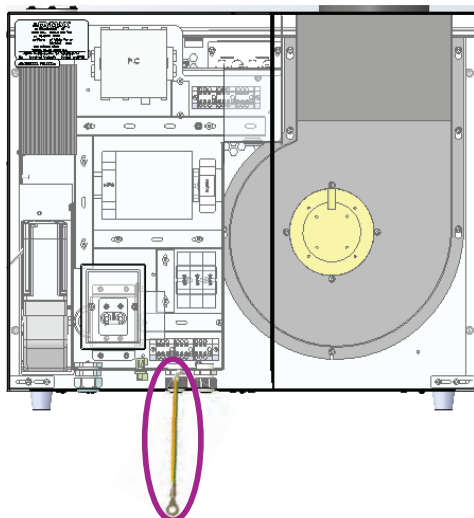
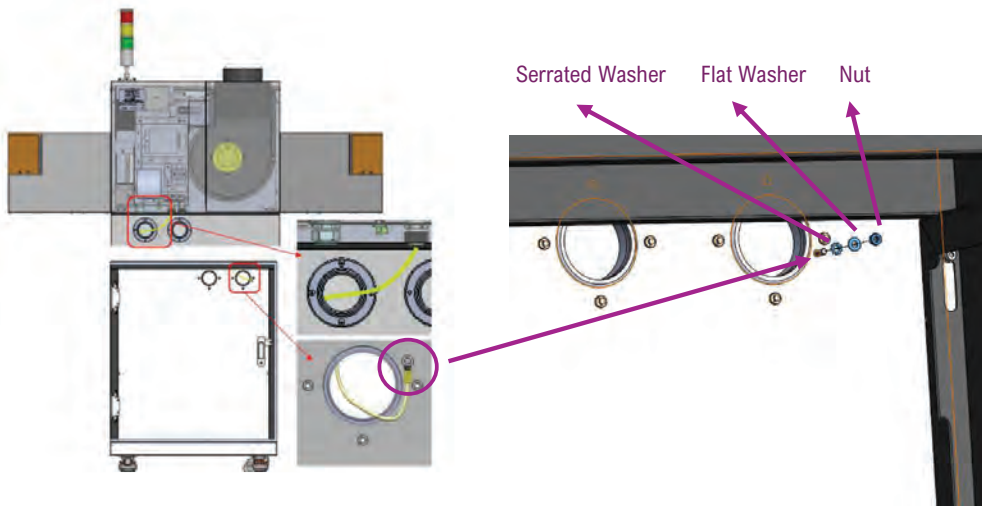

Figure 34.

Grounding Wire Connected to the Cabinet with Serrated Washer, Flat Washer and Nut as Shown



- 3) If you need to use the FX-1250 controller, please connect the network cable from the conveyor to the controller (Figure 35.) and plug the connection cable into the emitter: Roll the plug clockwise while inserting to plug the cable in. Roll the plug counterclockwise while removing to unplug the cable (Refer to BlueWave® FX-1250 user guide) (Figure 36.).

Figure 35.

Network Cable

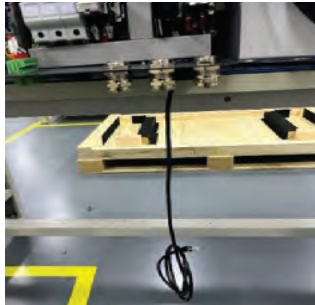

Figure 36.

Plugging Connection Cable into Controller



Plugging Connection Cable into Emitter



- 4) If using 2x FX-1250 controllers, please connect the network cable from the conveyor to the RJ45 socket interface on the right side of the primary controller (Figure 37.) and connect the primary controller to the secondary controller with the other network cable (Figure 37.), and connect the COM terminal of the PLC interface between the primary and secondary controllers (Figure 37.). And plug the connection cables into the emitters. (Refer to BlueWave® FX-1250 user guide).

Note: If your FX-1250 version is lower than V3.23.11, contact Dymax for software upgrades to ensure full functionality is achieved.

Figure 37.
Network Cable from the Primary to the Secondary Controller

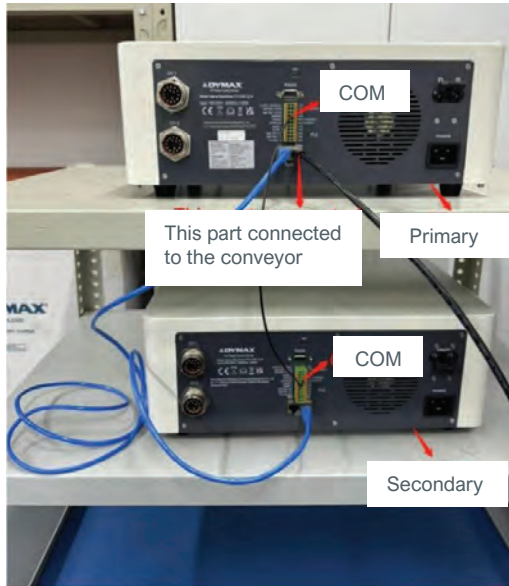

Figure 38.
ID for Multidevice Set: (Range: 0 -10)

0	Default. Single device
1	Primary-Conveyor
2-10	Secondary in multidevice net.



Turn On

Turn on the main switch of the equipment to supply power for the conveyor. The following (Figure 39.) shows the main switch of the conveyor.

Figure 39.
Power Supply Switch



Note: The cover of the power switch is made of plastic. Pay attention to protect it during use or transportation to prevent damage.

Emergency Stop

In case of an emergency requiring an immediate shutdown, press one of the emergency stop buttons while the conveyor is in operation. This action will halt the motor and the exhaust fan of the conveyor and emitters, while simultaneously activating the alarm. The operator needs to check the alarm logs of the conveyor and emitter and take corresponding measurements. The following Figure 40. shows the emergency stop buttons.

Figure 40.
Emergency Stop Buttons

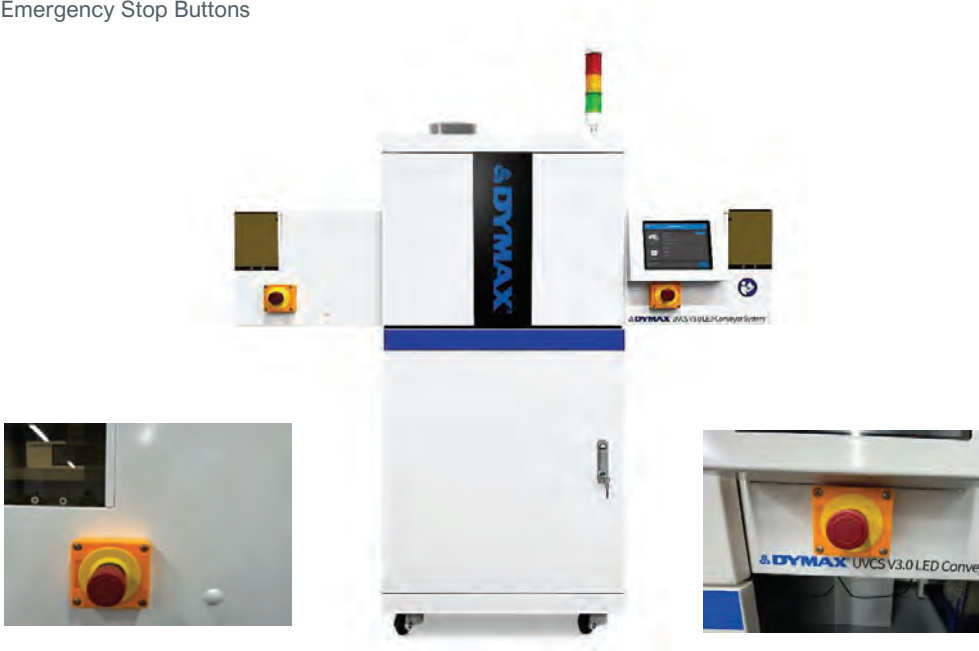

Note: When any alarm occurs in the conveyor system, the emergency stop button must be pressed first.

Operation

System Flow Chart

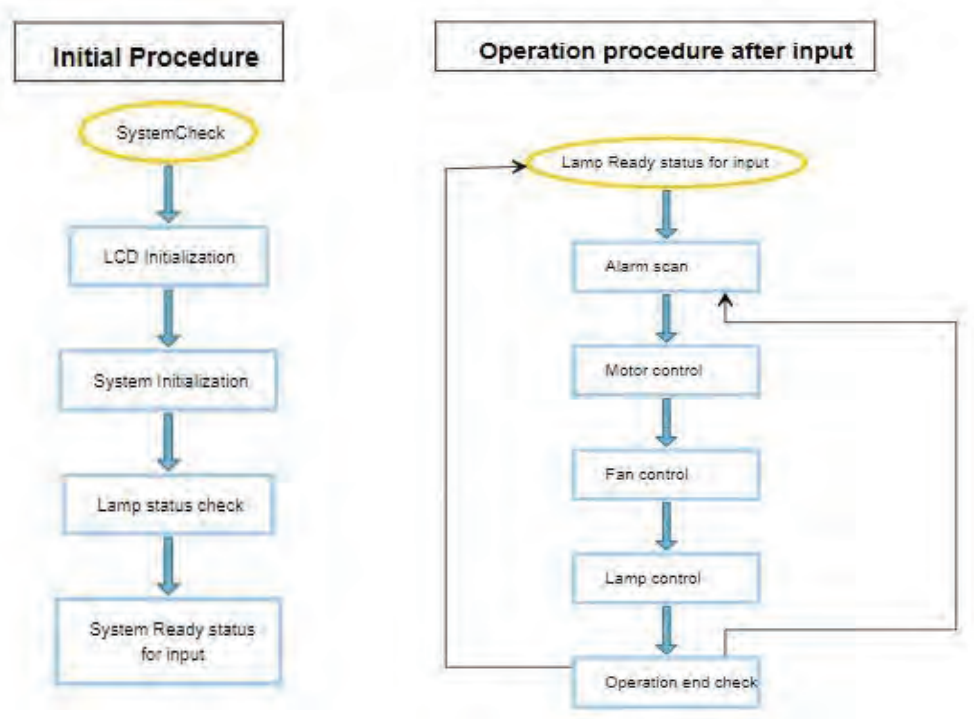

Start Up

- 1) Verify all connectors are firmly plugged into the rear panel of the controller and emitter.
- 2) On the rear panel of the controller, move the power switch to the ON position (up direction).
- 3) The start-up window (Figure 41.) will appear for several seconds as the system initializes.
- 4) After starting up, the main window appears.
- 5) **WARNING!** Emitters must be installed correctly before powering up. If no emitter is installed, the controller is not operable. Power off the controller and install at least one emitter.
- 6) The system is now ready to have emitter parameters set.
- 7) Firmware version: check in the HMI system
LCD version: check in the HMI system

Figure 41.
Start-Up Window



System Settings

Press the system setting button  on the Main Window. A password input window (Figure 42.) will appear. The password must be entered to enter the System Settings window.

Press the bar beside the lock on the password input window to activate the keyboard. (Figure 43)

The default password is set to "1234". Press CONFIRM to proceed to the next window.

Figure 42.

Password Input Bar



Figure 43.

Keypad for Password Window



Once the password is entered, the System Settings window (Figure 44.) appears.

Figure 44.

System Settings Window

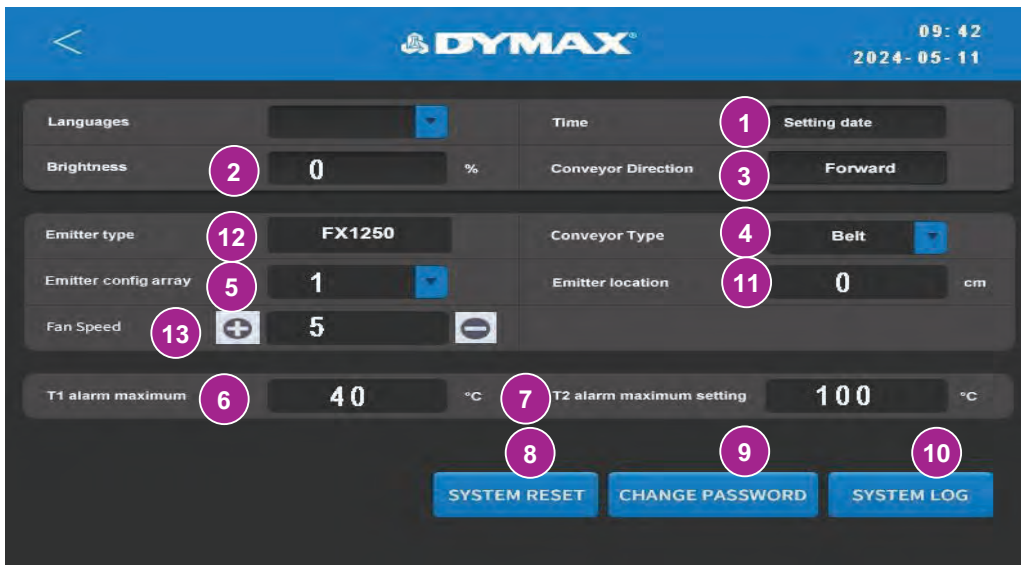

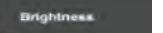

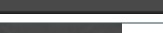
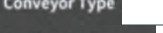
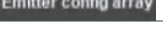

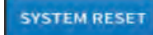

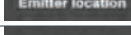



Table 3.

System Settings Window Functions

Number	Name	ICON	Description
1	Calendar and RTC		Set calendar and RTC time
2	Brightness		Set the LCD brightness
3	Conveyor Direction		Set the direction of belt movement
4	Conveyor type		Select the belt type or chain type of the conveyor
5	Emitter config array		Select the emitter array type
6	T1 alarm maximum temperature		Displays the value for the maximum temperature of T1

7	T2 alarm maximum temperature Setting		Set the value for the maximum temperature of T2 (100 – 150 °C)
8	System reset Button		Reset the important data in the system
9	Change password Button		Reset the password of the system
10	System log		Look up the alarm log
11	Emitter location		Add the distance from the LED array center in conveyor direction
12	Emitter type		Display the Lamp type
13	Exhaust Fan Speed		Set fan speed level from 1 to 5

Recommended Fan Speed

T2 (°C) Alarm Setting	Emitter Configuration				
	1x1	2x1	1x2	1x3	2x2
40 °C	3	4	4	NA	NA
50 °C	2	3	3	4	NA
60 °C	2	3	3	4	4
70 °C	2	3	3	4	4
80 °C	2	3	3	4	4
90 °C	2	3	3	4	4
100 °C	2	3	3	4	4
110 °C	2	3	3	4	4
120 °C	2	3	3	4	4
130 °C	2	3	3	4	4
140 °C	2	3	3	4	4
150 °C	2	3	3	4	4
Noise Level	3: 65 dba	4: 75 dba	4: 74 dba	4: 73 dba	4: 73dba
Test Condition					
1. Fan Speed: (1-5) 2. Emitter Height: 25 mm 3. Emitter Intensity: 100% 4. Ambient Temperature: 25 °C ± 2 5. Emitter: 365 nm * 4 6. UVCS V3.0 Belt Speed: 7.8 m/min (Forward)					

Note: When setting the fan speed, adjust the fan speed based on the actual environment temperature, working distance and intensity setting.

Brightness

Figure 45.

Brightness Adjustment Bar

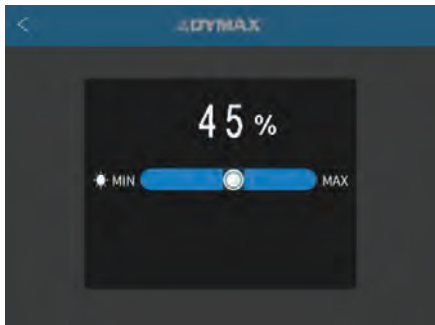

- 1) On the system settings window, press on the brightness button.
- 2) Move the bar left to right to adjust the brightness of the screen. The number above the bar displays the brightness value.
- 3) Press the back arrow in the left top corner to exit.

Clock and Calendar Settings

- 1) On the System Settings window, press the Time button.
(Figure 44., #1)
- 2) There are 5 values in the Time window
 - Y: Year
 - M: Month
 - D: Day
 - H: Hour
 - M: Minute
- 1) Press the upper blue line of the middle-row number to increase the value by 1 unit.
- 2) Press the lower blue line of the middle-row number to decrease the value by 1 unit.
- 3) After the time is set, press the CONFIRM button to set time.
- 4) Or press the CANCEL button to exit.

Note: Once powered off, the calendar can only be saved for 1 week.

Input the Password

- 1) Press the bar beside the lock to enter the password.
- 2) Press the CONFIRM button to check. If it is correct, the window proceeds to the next window.
- 3) Press the CANCEL button to exit
- 4) Default password is: 1234

Changing the Password

- 1) Press the Change Password button on the System Settings window (Figure 44., #9) to enter the Change Password window.
- 2) Press New Password to input the new password. (Figure 47.)
- 3) Press Confirm Password and input the new password again. The two input passwords must be identical.
- 4) Press the CONFIRM button to save the password.
- 5) Press the back arrow in the left top corner to exit.

System Reset

Press the System Reset button on the System Settings window to:

- Reset the password to the default setting: 1234
- Reset the program names and values to the default settings

Figure 46.
Clock and Time Input Pad

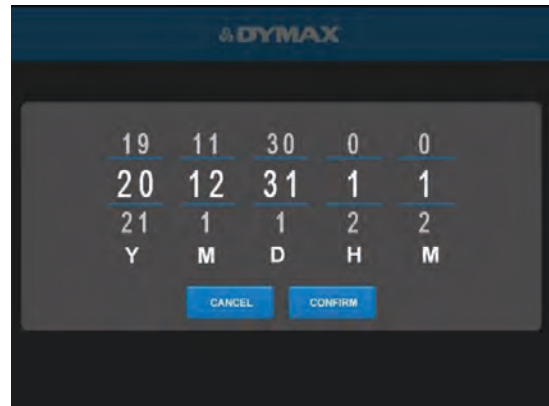
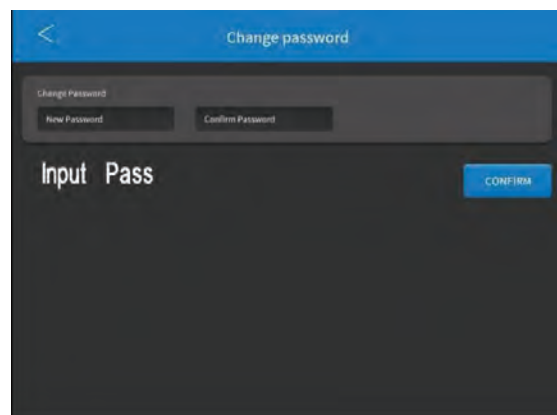
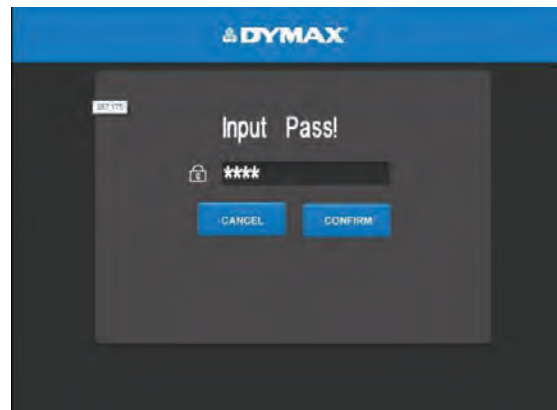

Figure 47.
Change Password Window



Main Window Settings

In the main window, the operator can:

- 1) Select the conveyor mode.
- 2) Set all emitters' power and cure time.
- 3) Start or stop the conveyor.

Figure 48.
Main Window

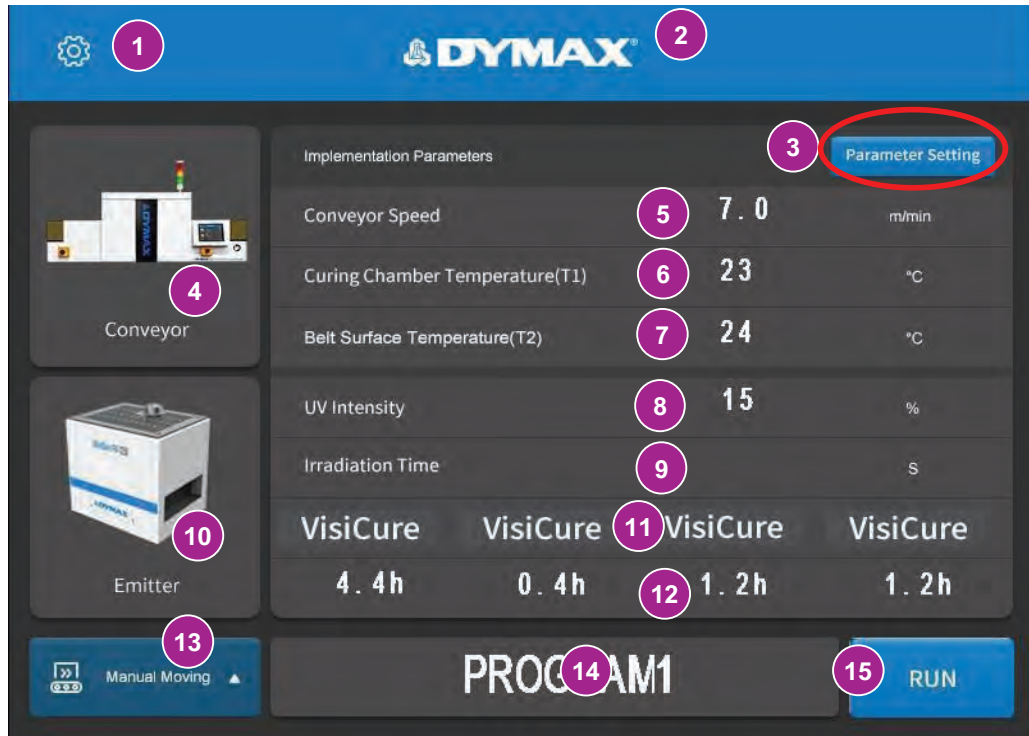



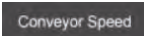
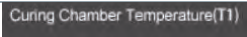

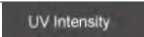

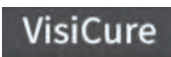

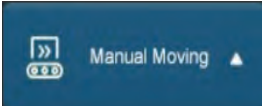





Table 4.
Main Window Functions

Number	Name	ICON	Description
1	System Setting		Press to enter the system setting window to set the system parameters (clock, calendar, password, brightness, emitter type, emitter location, etc)
2	Dymax Logo		
3	Parameter Setting		<ul style="list-style-type: none"> In moving mode, this window can be used to set speed, intensity, cure time, delay time In static mode, intensity, and cure time can be set. The cure time must be larger than 0 in this mode. <p>In program mode, a slot can be selected for storage and applying programs.</p>
4	Conveyor Type		Displays the conveyor type icon.
5	Conveyor Speed		The wheel speed is measured in meters per minute
6	Curing Chamber Temperature		Displays the curing chamber temperature
7	Belt Surface Temperature		Displays the surface temperature at the belt
8	UV Intensity		Displays the intensity of the UV emitter
9	Irradiation Time		Displays the time the emitters will be on in Static mode
10	Emitter Type Icon		Displays the emitter type
11	Emitter Type		Wavelength of connected emitter: PrimeCure (365 nm) VisiCure (385 nm) RediCure (405 nm)
12	Emitter Run Hours		Displays the running hours of the emitter
13	Mode		<p>Allows selection from three modes:</p> <ul style="list-style-type: none"> Manual Moving: the belt runs continuously Static mode: the belt runs in steps of fixed length Program mode: store and apply different parameters PLC: enter PLC mode
14	Program Name		Displays the applied program slot name
15	Start/Stop Button		<ul style="list-style-type: none"> Press Run button to start the conveyor Press Stop button to stop the conveyor

Note: (For Table 4 Line 14), When starting or stopping the conveyor, you need to hold down the RUN or Stop button for 3 seconds. Before starting the conveyor each time, users need to re-select and confirm the mode.

Select Conveyor Mode

- 1) Press the Mode button on the main window (Figure 48., #13) to enter the mode selection list.
- 2) Enter the admin password to verify.
- 3) Select a mode on the list to activate that mode (Figure 49.). An animation (below) will appear, then the mode will change.

- 4) Press the button at the end of the list to exit the list.

Set Moving Mode Parameters

- 1) Access the Mode Selection list from the main window (Figure 48., #13) and set the conveyor mode to Manual Moving (Figure 49.)
- 2) Enter the parameter setting window. (Figure 50.)
- 3) Press the Speed bar to set the belt wheel speed in m/min. (0.4 – 7.8)
- 4) Press the Intensity bar to set the UV power (10%-100%) of all the emitters.
- 5) Press the Wake Interval bar to set the cure time (0-9999 minutes) of the emitters. Enter the desired value using the pad and press enter. The new value will display in the bar.

Lamp Timeout – After the duration? set in this bar, the conveyor shuts down all emitters if there was no trigger during that time.
- 6) Press the APPLY button to update the parameters on this page to the current main window setting and save the setting.
- 7) If no changes are needed, press the back arrow in the left top corner to exit the parameter setting window.

Note: In moving mode, the curing emitters work continuously, and the curing time does not need to be set.

Note: Place a container at the end of the belt for collecting.

Figure 49.
Mode Selection List

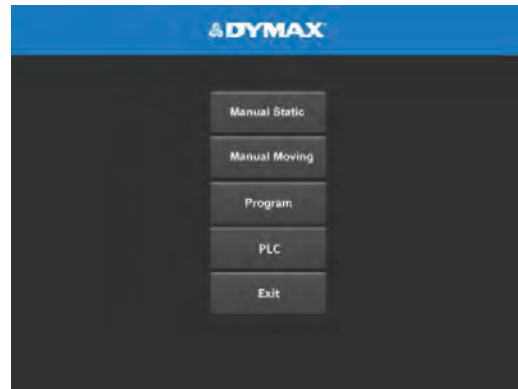
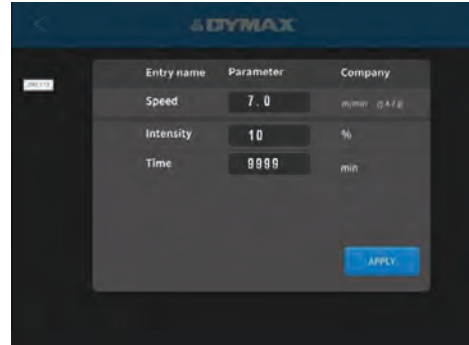

Figure 50.
Moving Mode, Parameters Window



Set Static Mode Parameters

- 1) Access the Mode Selection list from the main window (Figure 48., #13) and set the conveyor mode to Manual static (Figure 49.)
- 2) Enter the parameter setting window. (Figure 51.)
- 3) Press the Intensity bar to set the UV power (10%-100%) of all the emitters.
- 4) Press the Irradiation Time bar to set the cure time of the emitters. Enter the desired value using the pad and press enter. (0-9999 seconds). The new value will display in the bar.

- Set a value greater than 0s to run the emitter automatically for that duration. (0s is not permitted in this mode)

Cure times can be set in intervals of 1 sec.

- 5) Press the APPLY button to update the parameters on this page to the current main window setting.

Note: In static mode, the next item may be loaded to the belt after the DYNAMX LOGO turns on.

Note: High ambient temperatures can affect the operation of the FX emitters when operating at high intensities. To avoid high temperature alarms and shutdowns, the following maximum intensity settings are recommended based on the ambient temperature and emitter arrangement:

Ambient Temperature	Emitter Arrangement				
	1	1x2	1x3	2x1	2x2
25°C	100%	100%	100%	100%	100%
32°C	100%	100%	90%	100%	80%
40°C	80%	80%	70%	80%	60%

Note: If operating at higher ambient temperatures, please refer to the intensity parameters in the table above. Set and test the intensity to meet the usage requirements.

Setting the Emitter Location

- 1) On the main window (Figure 48.) press the system setting button to enter the system setting window.
- 2) In the system setting window, press the bar beside the emitter config array to select a LED array type (Figure 53.).

In static mode, the conveyor can send the parts to a location defined by this setting. Its value is defined by the distance from the input sensor to the end side of the emitter. The value is default according to emitter array in the chamber. The user can adjust the value according to their array.

Note: When the conveyor is in a constant temperature environment of 35 degrees, the default alarm temperature of T1 is 40 degrees. If you have special needs, change the number of emitters or change the ambient temperature or add protection.

- 3) The user can add some distance from the LED array center in the conveyor direction by inputting values in Emitter Location.

Figure 51.
Static Mode, Parameters Window

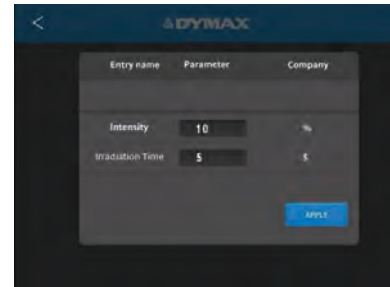

Figure 52.
Emitter Config. Array

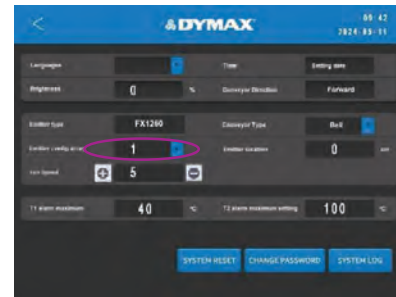

Figure 53.

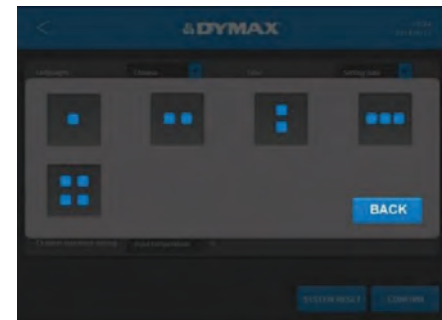
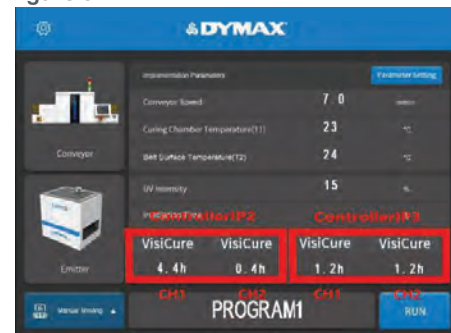

Figure 54.



Speed of Static Mode

- 1) The speed is programmed for accurate positioning.
- 2) It is fixed and cannot be changed by the user.

Program Settings

To save the set values in the main window, enter program mode by pressing the Mode Selection list on the main window, then select the Program. It is required to enter the user password correctly before entering the window.

Figure 55.

Program Window

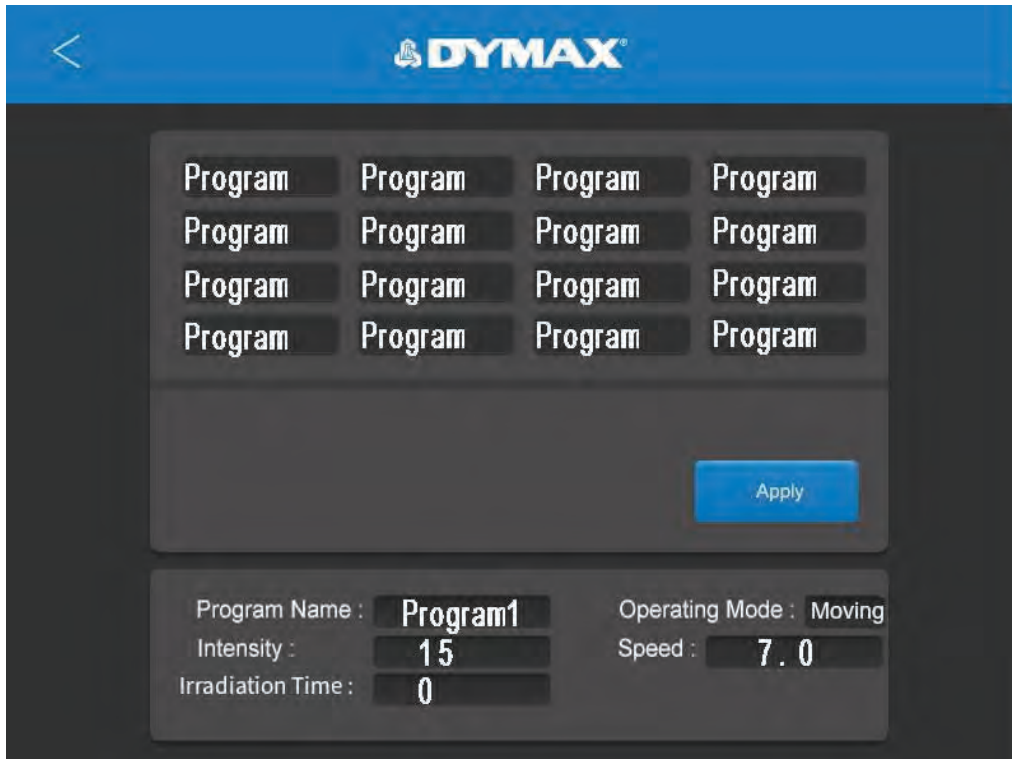

There are 16 slots for selection. Their default names are Program # (1-16). Only one slot can be selected at a time.

The operation steps are:

- 1) Press on a program slot. The program slot is marked by a blue check when selected. The parameters stored in that program slot are displayed in the bottom area.
- 2) Press the bar beside the Program Name in the bottom area to rename the slot.
- 3) Press the bar beside the Operating Mode to set the mode. Moving | Static.
- 4) Press the bar beside the Intensity to input the intensity.
- 5) Press the bar beside the Speed to input the belt wheel speed.
- 6) Press the bar beside the Irradiation Time to input the cure time.
- 7) Press the Apply button to save and update the program parameters to the main window.
- 8) Press the back arrow in the top left corner to exit the program window.

System Log

Checking the Alarm History Log

To check the alarm history log, press the Alarm Log window. The error window will appear. (Figure 56.)

Note: The alarm records are only updated. They can't be deleted. The lines show the date and time of the alarm, and the code to describe the reason for the alarm.

The controller can save a maximum of 100 records. When over 100 alarms have been recorded, the next number is overlaid by the new alarm.

Press the arrow to move the page number up and down.

Press a number to go to the specified page.

Press the Back arrow to return to the main window.

When the Controller Receives an Alarm

When the controller receives an alarm, the controller is forced to enter the Alarm Popup window. Press Turn Off the Alarm (Figure 57.) to enter the Alarm Active window. In this window, you can stop the alarm by pressing the red bell icon at the bottom of the window (Figure 58.).

After the alarm code is checked, shut down the machine to restart.

In the System Setting window, press the system log button to check the history.

When an alarm occurs, the emitters are stopped, and the controller beeps.

Press the Reset button to turn off the beep and disable the alarm.

WARNING! Power off before checking the controller and emitters.

Every alarm message has the time of occurrence, alarm code and alarm message.

Note: When pressing the emergency stop button, if rerun the conveyor, turn off the power switch, and then turn on the power switch.

Figure 56.
Alarm Log Window

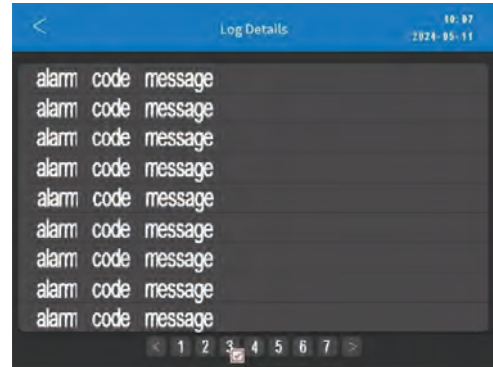

Figure 57.
Alarm Popup Window



Figure 58.
Alarm Active Window

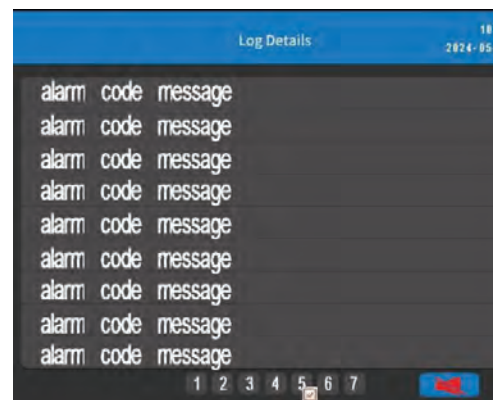

Table 5.

Alarm Codes and Description

Alarm Code	ALARM message	Cause
0x0001	EMERGENCY STOP!	The emergency button is pushed in.
0x0002	CHAM TEMP HIGH!	T1 or T2 is over the maximum temperature.
0x0003	DOOR OPEN!	The conveyor door is open.
0x0004	MOTOR ERROR!	Motor is reporting an error.
0x0005	MOTOR CONNECT!	Motor communication is not connected.
0x0007	FX1250 ERROR!	FX1250 device has errors or communication problems
0x0008	FAN ERROR!	Exhaust fan is not working.

If the LCD is disconnected, the alarm will turn red and produce a buzzing sound. An icon (Figure 59.) indicating the error will appear on the HMI.

Figure 59.



Should the Emergency Stop button be activated or in case of a sudden emergency, strictly follow these steps:

1. Turn off the power supplies for the emitters and shut down the conveyor's power.
2. Release the emergency stop button.
3. Analyze and troubleshoot any potential issue.

Troubleshooting

Table 6.

Alarm Code	ALARM message	Suggestion
0x0001	EMERGENCY STOP!	Check the emergency button.
0x0002	CHAM TEMP HIGH!	<ol style="list-style-type: none">1) Check fan status.2) Check sensor connection.3) Check the fan of LED emitter.4) Check the environment temperature.
0x0003	DOOR OPEN!	Check the cover of the conveyor.
0x0004	MOTOR ERROR!	<p>The motor is experiencing an internal error.</p> <ol style="list-style-type: none">1) First, verify if the belt is running smoothly.2) Check if the load on the conveyor is excessive, as this could lead to overburdening.
0x0005	MOTOR CONNECT!	Check the motor connect wire.
0x0007	FX1250 ERROR!	<p>The FX-1250 has errors or communication problems.</p> <ol style="list-style-type: none">1) Make sure the FX-1250 operates properly independent of the conveyor system.2) Verify the integrity of the cables being used, and ensure they are properly connected.3) Set correct ID (2 or 3).4) Correct wire connection.
0x0008	FAN ERROR!	Check fan status.

PLC Mode

There are 2 working modes:

Default: This is the default mode and is operable by the touch screen. Parameters can be stored in the program slots and called for operation.

PLC: The system can be controlled by PLC. This mode is triggered by selecting the “PLC” mode in the mode list (see Select Conveyor Mode). Please follow the wiring guide in “PLC UV Control”.

PLC UV Control

PLC switching may be driven by manual switch, relay, or optical coupler.

To use the PLC mode, first, set the parameter setting in manual moving mode or static mode, then select the PLC MODE (See Figure 60.) in the mode list to enter the PLC window.

Figure 60.
PLC Mode Window

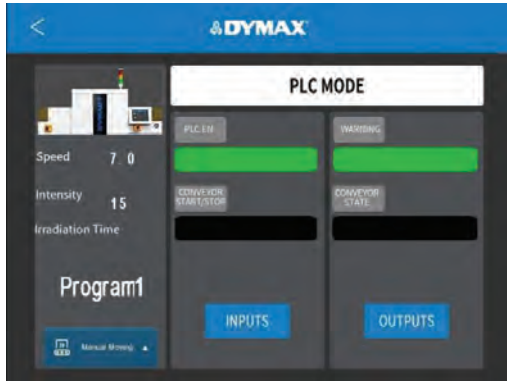

You can click the back arrow to exit the PLC mode. Before exiting, a password window will appear prompting you to enter the admin password.

PLC Output and Input

The green interface terminal is the input and output ports of internal and external signals.

Figure 61.
PLC Connector

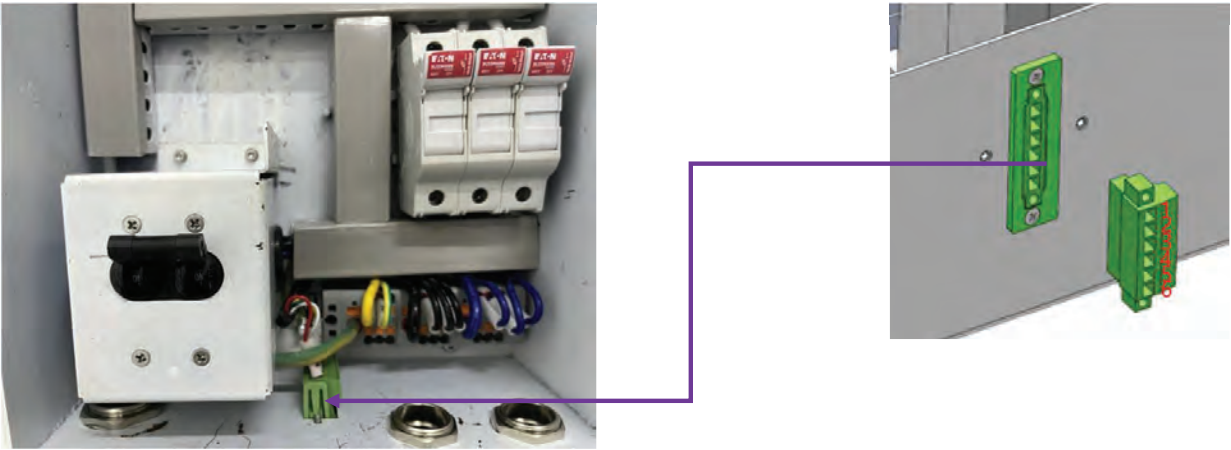

There are two status outputs. They are driven by an optical coupler. These outputs work in any mode and can be used as status inputs for PLC or any status display/monitor purpose.

- **WARNING** - Output low to indicate the unit is normally working.
- **Conveyor State** - Output low to indicate the UV LEDs are ON.

The example application of these signals is shown below.

Figure 62.
Status Outputs Connection to Customer's Monitor Device

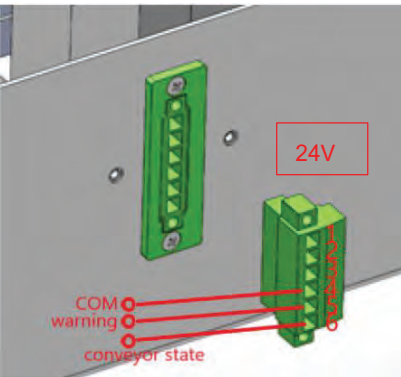

PLC IO channel is a 24V source available for use to drive PLC logic but must be current limited using pull-down resistors to protect the device when directly attached to the I/O channels through the PLC connector. The max support current is 50 mA.

Figure 63.
Examples of Customer Configurations for Monitoring Outputs

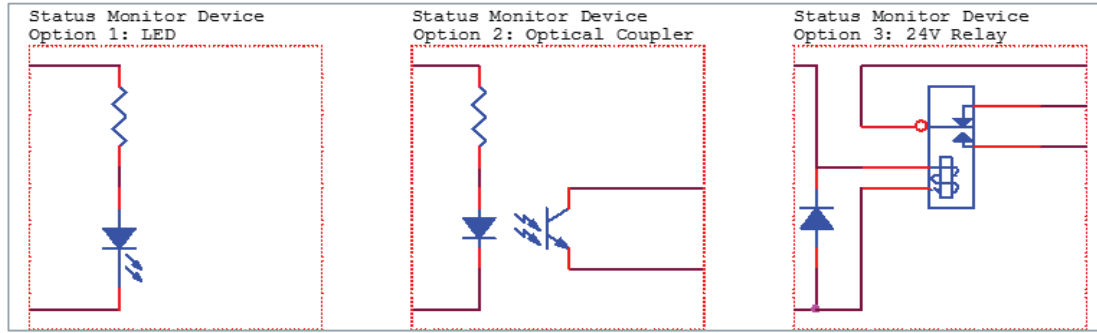

PLC input connection shows the conveyor start in the following figure.

Figure 64.
PLC Input Connection

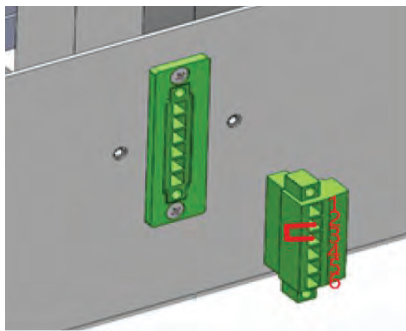

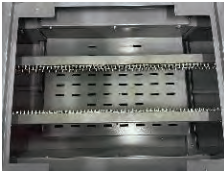

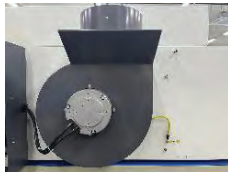
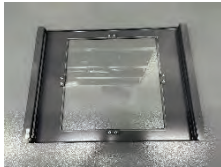



Table 7.
The green terminal interface shown in Figure 62. is defined as follows:

Signal Name	Pin #	Description	
INPUTS			
Input Reserve	1	Do Not Use	Input Reserve
CONVEYOR START/STOP	2	Protective interface: 0V- On; 24V/Open-Shut OFF.	Can be used as a start/stop. 0V can be used for normal operation.
COM	3	Common	Common
OUTPUTS			
WARNING	5	System fault indication: 24V- fault; Open- Working	Relay output: 24V: the system is in failure, the output is on, and with an alarm. Open: the system is working.
CONVEYOR STATE	6	Working status indicator: Open-Working; 24V-Shut OFF.	The signal is open, the system is running. The signal is 24V, the system will be in an inactive state.
COM	4	Common	Common

Maintenance

Routine Maintenance

NO	Module	Item	Requirement	Example	Cycle
1	Driving Section	Belt	Check for wear; replace belt if worn out		Weekly
2		Roller	Check for wear; replace rollers if worn out		Monthly
3		Edge	Add lubricant		Monthly
4		Sprocket wheel	Add lubricant		Monthly
5	Cooling Section	Exhaust fan	Dust off		Monthly
6		Exhaust fan box	Dust off		Monthly
7		Windshield glass	Dust off		Monthly
8		Temperature sensor	Check for correct operation; replace damaged or aged wiring harness		Monthly

Spare Parts & Accessories

Accessories

Item	Part Number
CRADLE HORIZONTAL CONFIGURATION FOR 1x1 1x2 1x3	80021
CRADLE VERTICAL CONFIGURATION FOR 1x2 2x2	80022
CABINET, CONVEYOR SYSTEM	80020
PROTECTIVE GOGGLES-GRAY (STANDARD MODEL INCLUDED WITH UNIT)	84126
INTERCONNECT CABLE, 2M TYPE L & L	84025
INTERCONNECT CABLE, 2M TYPE I & L	84026
INTERCONNECT CABLE, 5M TYPE L & L	84027
INTERCONNECT CABLE, 5M TYPE I & L	84028
ACCU-CAL 160 LED, COMPLETE	41585
BLUEWAVE FX 1250 EMITTER REDICURE (365NM)	88801
BLUEWAVE FX 1250 EMITTER PRIMECURE (385NM)	88802
BLUEWAVE FX 1250 EMITTER VISICURE (405NM)	88803
BLUEWAVE FX 1250 CONTROLLER 1CH (CHINA CORD)	88805
BLUEWAVE FX 1250 CONTROLLER 2CH (CHINA CORD)	88804
BLUEWAVE FX 1250 CONTROLLER 1CH (NORTH AMERICA CORD)	88846
BLUEWAVE FX 1250 CONTROLLER 2CH (NORTH AMERICA CORD)	88847
BLUEWAVE FX 1250 CONTROLLER 1CH (NO CORD)	88850
BLUEWAVE FX 1250 CONTROLLER 2CH (NO CORD)	88851
NETWORK WIRE,5M	84458

Components & Spare Parts

Item	Part Number
BELT, W300*L2875, UVCS V3.0	83105
SHIELD	81216
DRIVE PULLEY	83100
IDLE PULLEY	83101
BELT CURTAIN	83113
RUBBER BUMPER	83108
TRI-COLOUR LIGHT	84132
DRIVE MOTOR	84172
REDUCTION GEARS	84173
MOTORIZED IMPELLER, 230VAC	84128
MOTORIZED IMPELLER,115VAC	84171
UVCS V3.0 BELT 110V NA (TYPE B POWER CORD) WITH HORIZONTAL CRADLE	88880
UVCS V3.0 BELT 110V NA (TYPE B POWER CORD) WITH VERTICAL CRADLE	88881
UVCS V3.0 EDGE 110V NA (TYPE B POWER CORD) WITH HORIZONTAL CRADLE	88882
UVCS V3.0 EDGE 110V NA (TYPE B POWER CORD) WITH VERTICAL CRADLE	88883
UVCS V3.0 BELT 220V CN (TYPE I POWER CORD) WITH HORIZONTAL CRADLE	88884
UVCS V3.0 BELT 220V CN (TYPE I POWER CORD) WITH VERTICAL CRADLE	88885
UVCS V3.0 EDGE 220V CN (TYPE I POWER CORD) WITH HORIZONTAL CRADLE	88886
UVCS V3.0 EDGE 220V CN (TYPE I POWER CORD) WITH VERTICAL CRADLE	88887
UVCS V3.0 BELT 220V EU (TYPE F POWER CORD) WITH HORIZONTAL CRADLE	88888
UVCS V3.0 BELT 220V EU (TYPE F POWER CORD) WITH VERTICAL CRADLE	88889
UVCS V3.0 EDGE 220V EU (TYPE F POWER CORD) WITH HORIZONTAL CRADLE	88890
UVCS V3.0 EDGE 220V EU (TYPE F POWER CORD) WITH VERTICAL CRADLE	88891
UVCS V3.0 BELT 220V UK/ASIA (TYPE G POWER CORD) WITH HORIZONTAL CRADLE	88896
UVCS V3.0 BELT 220V UK/ASIA (TYPE G POWER CORD) WITH VERTICAL CRADLE	88897
UVCS V3.0 EDGE 220V UK/ASIA (TYPE G POWER CORD) WITH HORIZONTAL CRADLE	88898
UVCS V3.0 EDGE 220V UK/ASIA (TYPE G POWER CORD) WITH VERTICAL CRADLE	88899

Product Specifications

Table 8.
Product Specifications and Electrical Requirements

Property	Specification
Model	UVCS V3.0
Size	Conveyor: 1420 x 715 x 826 mm Cabinet: 640 x 512 x 820 mm
Weight	Conveyor: 90 kg Cabinet: 40 kg
Maximum Parts Height	152 mm
Belt/Edge Speed	0.4 ~ 7.8 m/min
Belt Width	300 mm
Edge-Carry Width	38 ~ 255 mm
Lamp Height Adjustment	12 ~ 152 mm
Operation Temp/Humidity	-10 ~ 40 °C, Non-condensing
Storage Temp/Humidity	-20~ 50 °C, Non-condensing
Power Input	North America: AC 90 ~ 125 V, 50/60 HZ, 3 A China & Europe: AC 196~264 V, 50/60 HZ, 1.5 A
Maximum Load Capacity	25 kg
Ingress Protection	IP 33

Conveyor Dimension

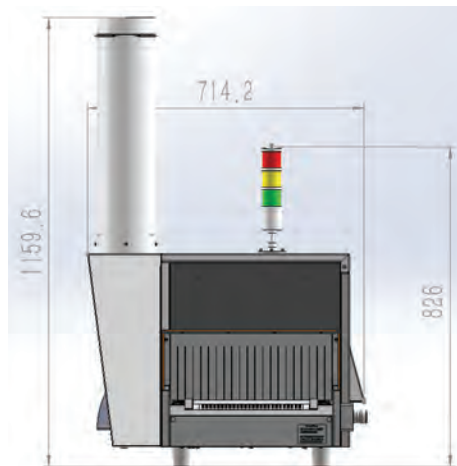
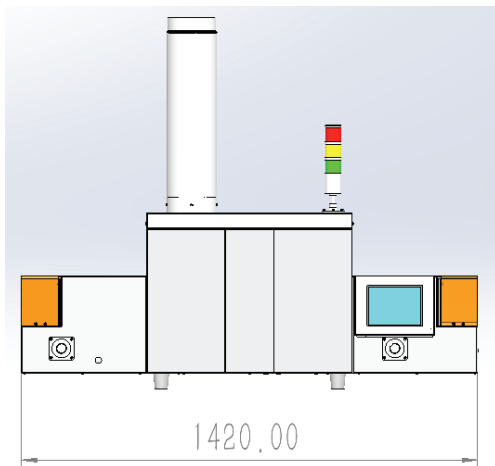

Cabinet Dimension

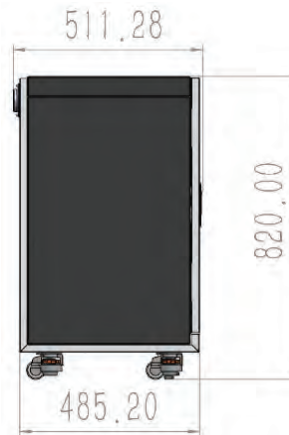

Declaration of Conformity

Figure 65.

Declaration of Conformity – CE



EU Declaration of Conformity Original

Manufacture:
 Hanarey Chemicals (Shanghai)
 Co., Ltd.
 No.111 Muhua Road, Fengxian
 District, Shanghai, China 201507

Authorised person to compile the technical file: Dymax Europe GmbH
 Christian Gruber
 Kasteler Strasse 45, Building G 359,65203 Wiesbaden Germany

Product description: UVCS V3.0 LED Conveyor System
 Model name(s): UVCS V3.0 LED Belt 220V
 UVCS V3.0 LED Edge 220V
 UVCS V3.0 LED Belt 110V
 UVCS V3.0 LED Edge 110V

This product complies with the following relevant Union Harmonization Legislation:

Machinery Directive(2006/42/EC)	Applicable Harmonized Standards: EN ISO 12100:2010 EN 60204-1:2018 EN 619:2022
Electromagnetic Compatibility Directive(2014/30/EU)	EN IEC 61000-6-2:2019 EN IEC 61000-6-4:2019
RoHS Directive 2011/65/ EU (incl.(EU) 2015/863)	EN IEC 63000:2018

Declaration:
 This declaration of conformity is issued under the sole responsibility of the manufacturer.
 Signed for and on behalf of Hanarey Chemicals (Shanghai) Co.,Ltd

[Signature] *2020.3.29* *Shanghai* **CE**
 Name Date Location

Authorized Signatory:
 Kyle Zhu
 Senior Manager, Equipment Development
 Hanarey Chemicals (Shanghai) Co., Ltd.



North America: +1 860.482.1010 | Europe: +49 611.962.7900 | Asia: +65.67522887

© 2021-2022 Dymax Corporation. All rights reserved. All trademarks in this guide, except where noted, are the property of, or used under license by Dymax Corporation, U.S.A. Please note that most dispensing and curing system applications are unique. Dymax does not warrant the fitness of the product for the intended application. Any warranty applicable to the product, its application and use is strictly limited to that contained in Dymax's standard Conditions of Sale. Dymax recommends that any intended application be evaluated and tested by the user to ensure that desired performance criteria are satisfied. Dymax is willing to assist users in their performance testing and evaluation by offering equipment trial rental and training programs to assist in such testing and evaluations. Data sheets are available for valve controllers or pressure pots upon request.

Figure 66.
Declaration of Conformity - UKCA



UK Declaration of Conformity Original

Manufacture:
Hanarey Chemicals (Shanghai) Co., Ltd.
No.111 Muhua Road, Fengxian District, Shanghai,
China 201507

Authorised person to compile the technical file: Kelvin Westcott
18 Hunts Grove Drive
Hardwick
GL2 2BH
United Kingdom

Product description: UVCS V3.0 LED Conveyor System
Model name(s): UVCS V3.0 LED Belt 220V
UVCS V3.0 LED Edge 220V
UVCS V3.0 LED Belt 110V
UVCS V3.0 LED Edge 110V

This product complies with the following relevant UK Legislation:

Applicable UK legislation:	Applicable Harmonized Standards:
Supply of Machinery (Safety) Regulations 2008	EN ISO 12100:2010
	EN 60204-1:2018
	EN 619:2022
Electromagnetic Compatibility Regulations 2016	EN IEC 61000-6-2:2019
	EN IEC 61000-6-4:2019
The Restriction of the Use of Certain Hazardous Substances in Electrical and Electronic Equipment Regulations 2012	EN IEC 63000:2018

Declaration:
This declaration of conformity is issued under the sole responsibility of the manufacturer.
Signed for and on behalf of: Hanarey Chemicals (Shanghai) Co., Ltd

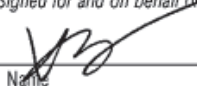
 2024.3.29 Shanghai
Name Date Location

Authorized Signatory:
Kyle Zhu
Senior Manager, Equipment Development
Hanarey Chemicals (Shanghai) Co., Ltd.



North America: +1 860.482.1010 | Europe: +49 611.962.7900 | Asia: +65.67522887
 © 2021-2022 Dymax Corporation. All rights reserved. All trademarks in this guide, except where noted, are the property of, or used under license by Dymax Corporation, U.S.A.
 Please note that most dispensing and curing system applications are unique. Dymax does not warrant the fitness of the product for the intended application. Any warranty applicable to the product, its application and use is strictly limited to that contained in Dymax's standard Conditions of Sale. Dymax recommends that any intended application be evaluated and tested by the user to ensure that desired performance criteria are satisfied. Dymax is willing to assist users in their performance testing and evaluation by offering equipment trial rental and leasing programs to assist in such testing and evaluations. Data sheets are available for VUV controllers on request upon request.

Validation

Tests should be conducted prior to production to determine the time and light intensity required to fully cure your resin. The following approaches may be used to validate the curing process.

Set Exposure Time, Determine Intensity

Users can specify a cure time and, through empirical testing, determine the intensity required to achieve a full cure. As with any manufacturing process, it is advisable to incorporate a safety factor.

Set Intensity, Determine Exposure Time

Users can specify light intensity and, through empirical testing, determine the exposure time required to achieve a full cure. As with any manufacturing process, it is advisable to incorporate a safety factor.

NOTE: *Dymax recommends low intensities at first to preserve LED life.*

Contact the Dymax Application Engineering Team for additional process support.

Control

Process validation confirms a minimum acceptable intensity. Users can then choose to operate at full intensity (using the excess intensity as an additional safety factor) or adjust the output to a specific intensity level. To ensure consistent and repeatable process results, intensity levels should be monitored with a radiometer. This enables users to identify light intensity changes and take corrective action (either adjusting the light intensity or performing maintenance).

Warranty

From date of purchase, Dymax Corporation offers a one-year warranty against defects in material and workmanship on all system components with proof of purchase and purchase date. Unauthorized repair, modification, or improper use of equipment may void your warranty benefits. The use of aftermarket replacement parts not supplied or approved by Dymax Corporation, will void any effective warranties and may result in damage to the equipment.

IMPORTANT NOTE: DYMAX CORPORATION RESERVES THE RIGHT TO INVALIDATE ANY WARRANTIES, EXPRESSED OR IMPLIED, DUE TO ANY REPAIRS PERFORMED OR ATTEMPTED ON DYMAX EQUIPMENT WITHOUT WRITTEN AUTHORIZATION FROM DYMAX. THOSE CORRECTIVE ACTIONS LISTED ABOVE ARE LIMITED TO THIS AUTHORIZATION

Index

Accessories, 36

Connections

PLC UV Control, 32

Status Output, 33

Contact Information, 4

Declaration of Conformity, 39

UK CA, 40

Features & Benefits, 9

Help, 4

Install Emitter and Controller on the Conveyor, 12

Main Components, 7

Operation, 20

Parts Included, 6

PLC Mode, 32

PLC Mode Signals, 34

Program Settings, 28

Safety, 4

Select Conveyor Mode, 26

Settings, 21

Clock and Calendar, 23

Password, 23

System Log, 29

System Reset, 23

Spare Parts, 36

Specifications, 38

Support, 4

System Assembly

Wiring and Connections, 16

Unpacking, 6

Validation, 41

Control, 41

Warranty, 42

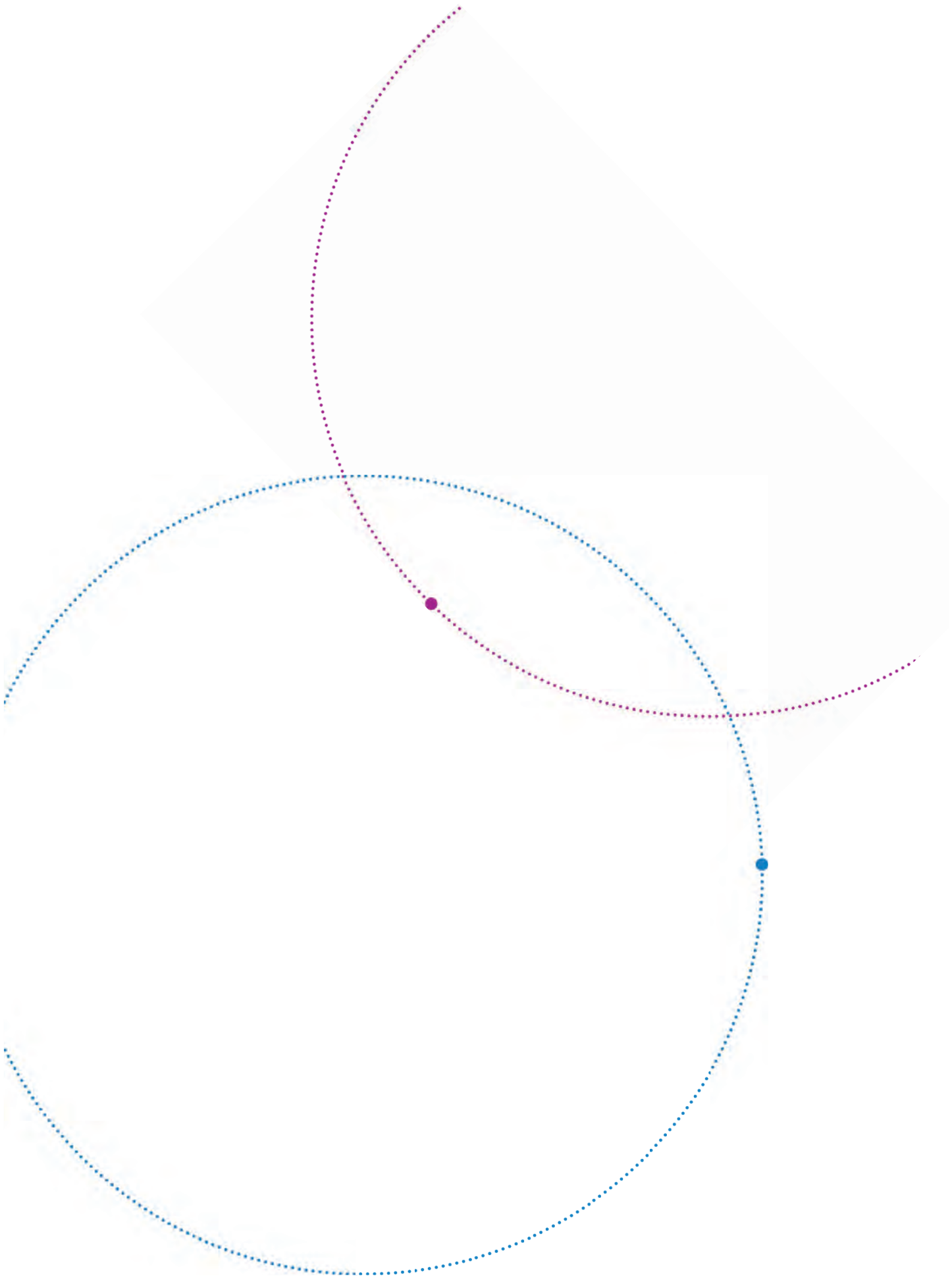

Manufacturer

Hanarey Chemicals (Shanghai)
Co., Ltd.
No.111 Muhua Road,
Fengxian District,
Shanghai, China 201507

Sales Representatives

North America:

Dymax Corporation
318 Industrial Lane
Torrington, CT 06790,
USA

Europe:

Dymax Europe GmbH
Kasteler Str. 45
Geb. G359
Wiesbaden, Germany
65203

United Kingdom:

Dymax
1b Hunts Grove Drive,
Hardwick, Gloucester,
Gloucestershire, GL2
4BH United Kingdom

Asia & Pacific:

Dymax Asia Pacific Pte Ltd
Block 5008, Ang Mo Kio Ave 5,
#05-03, Techplace II
Singapore 569874



www.dymax.com

North America: +1 860.482.1010 | Europe: +49 611.962.7900 | Asia: +65.67522887

© 2024 Dymax Corporation. All rights reserved. All trademarks in this guide, except where noted, are the property of, or used under license by Dymax Corporation, U.S.A.

Please note that most dispensing and curing system applications are unique. Dymax does not warrant the fitness of the product for the intended application. Any warranty applicable to the product, its application and use is strictly limited to that contained in Dymax's standard Conditions of Sale. Dymax recommends that any intended application be evaluated and tested by the user to ensure that desired performance criteria are satisfied. Dymax is willing to assist users in their performance testing and evaluation by offering equipment trial rental and leasing programs to assist in such testing and evaluations. Data sheets are available for valve controllers or pressure pots upon request. MAN127 5/28/2024