



BlueWave® QX4 V2.0

Multi-Head LED Spot Lamp System User
Guide
Rev: D



About Dymax

UV/Visible light-curable adhesives. Systems for light curing, fluid dispensing, and fluid packaging.

Dymax manufactures industrial, light-curable, epoxy, and activator-cured adhesives. We also manufacture a complete line of manual fluid dispensing systems, automatic fluid dispensing systems, and light-curing systems. Light-curing systems include LED light sources, spot, flood, and conveyor systems designed for compatibility and high performance with Dymax adhesives.

Dymax adhesives and light-curing systems optimize the speed of automated assembly, allow for in-line inspection, and increase throughput. System designs enable stand-alone configuration or integration into your existing assembly line.

Please note that most dispensing and curing system applications are unique. Dymax does not warrant the fitness of the product for the intended application. Any warranty applicable to the product, its application, and use is strictly limited to that contained in the Dymax standard Conditions of Sale. Dymax recommends that any intended application be evaluated and tested by the user to ensure that desired performance criteria are satisfied. Dymax is willing to assist users in their performance testing and evaluation. Data sheets are available for valve controllers or pressure pots upon request.

Contents

Introduction	4
Intended Audience.....	4
Where to Get Help.....	4
Safety	4
Product Overview	5
Description of the BlueWave QX4 V2.0.....	5
Features & Benefits.....	5
Validation	6
Front LCD Panel.....	6
Back Panel.....	7
Unpacking	8
Parts Included	8
System Setup	8
System Connections.....	8
LED Heads & Lenses.....	9
Operation	10
ADMIN Mode.....	10
PRODUCTION Mode	11
PLC Operation	12
System Settings	16
System Information	17
Cleaning & Maintenance	18
LED Head Optic Lens	18
Alarm Messages	18
Troubleshooting	19
Spare Parts and Accessories	20
Specifications	21
Declaration of Conformity	23
Warranty	25
Index	25

Introduction

This guide describes how to set up, use, and maintain the BlueWave® QX4 V2.0 LED spot-curing system safely and efficiently.

Intended Audience

Dymax prepared this user guide for experienced process engineers, technicians, and manufacturing personnel. If you are new to high-intensity LED light sources and do not understand the instructions, contact Dymax Application Engineering for answers to your questions before using the equipment.

Where to Get Help

Dymax Customer Support and Application Engineering teams are available by phone and email in the United States, Monday through Friday, from 8:00 a.m. to 5:30 p.m. Eastern Standard Time, and in Germany, Monday through Friday, from 8:00 a.m. to 5:00 p.m. Central European Time. You can also email Dymax at info@dymax.com or Dymax Europe GmbH at info_de@dymax.com. Contact information for additional Dymax locations can be found on the back cover of this user guide.

Additional resources are available to ensure a trouble-free experience with our products:

- Detailed product information on our website www.dymax.com & www.dymax.de
- Dymax adhesive Product Data Sheets on our website
- Safety Data Sheets (SDS) provided with shipments of Dymax adhesives

Safety

 **WARNING!** If you use this UV light source without first reading and understanding the information in the **UV Light Safety Guide, SAF001**, injury can result from exposure to high-intensity light. To reduce the risk of injury, please read and ensure you understand the information in that guide before assembling and operating the Dymax UV LED light source.

To use the BlueWave QX4 V2.0 system safely, it must be set up and operated in accordance with the instructions given by Dymax. Using the system in any other manner will impair the protection of the system. Dymax assumes no liability for any changes that may impair the protection of the BlueWave QX4 V2.0 system.

This device falls under IEC 62471 Risk Group 2 for UVA and blue light emissions:

 **WARNING!** Looking directly at the high-intensity light emitted by the LED heads of the BlueWave QX4 V2.0 can result in eye injury. To prevent eye injury, never look directly at the end of the high-intensity LED head and always wear protective goggles. To avoid accidental exposure, always point the LED head away and at the curing substrate.

 **WARNING!** UV emitted from this product. Avoid eye and skin exposure to unshielded products.

 **WARNING!** Possibly hazardous optical radiation emitted from this product. Do not look at operating lamp. Eye injury may result.

Removing the cover from the BlueWave QX4 V2.0 controller may result in electrical shock. To prevent the possibility of an electrical shock, never remove the controller's cover. The controller is cooled by natural convection. If you block the air flow from the controller, equipment damage and malfunction can result. To prevent damage and malfunction, ensure adequate space around controller vents to allow the free flow of air. Typically, 1.5 in of space around all sides of the controller is sufficient.

WARNING! Under NO circumstances should the interconnect cable from the controller to the LED emitter be connected or disconnected while power to the unit is on. This procedure is usually called "hot swapping" and should not be performed as it could cause damage to the controller or the emitter. Always power down the equipment before disconnecting or connecting any of these devices.

Product Overview

Description of the BlueWave QX4 V2.0

The BlueWave QX4 V2.0 high-intensity spot-curing system features all the benefits of LED-curing technology in a smaller, more versatile unit. This system is comprised of a power supply, a controller with an easy-to-use control interface, and up to four LED heads. LED heads are available in RediCure (365 nm), PrimeCure (385 nm), and VisiCure (405 nm) and can be outfitted with 3-, 5-, or 8-mm diameter focusing lenses. LED heads and focusing lenses can be used in any combination and can be operated in constant or variable mode. The system is designed to maximize operator safety and minimize exposure to light curing energy.

The system's LED heads can be used as hand-held units or integrated into an automated manufacturing system allowing for maximum application flexibility. Their output intensity levels can also be adjusted from 10% to 100% to meet process and adhesive requirements.

Figure 1.
Main Components of a BlueWave QX4 V2.0

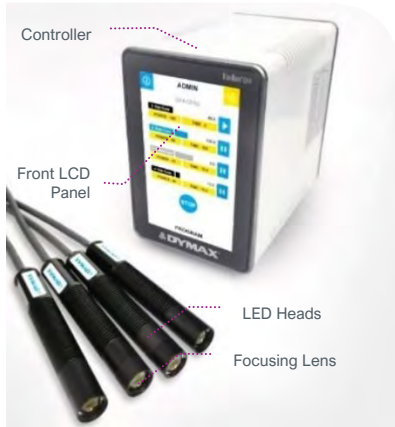

Features & Benefits

The Dymax BlueWave QX4 V2.0 is engineered for precise performance and long service life. Key features include:

Features	Benefits
One controller operates up to four LED heads	<ul style="list-style-type: none">Provides maximum application flexibility
LED heads are available in 365, 385, or 405 nm wavelengths	<ul style="list-style-type: none">Compatible with a variety of UV and visible light-curable materialsWavelengths can be mixed to produce optimal curesUnits can be custom configured to curing requirements
Variable mode allows each LED head to be programmed independently	<ul style="list-style-type: none">Exposure times and intensity settings can be set in 1% increments for each LED head individually, allowing maximum curing flexibilityTimer mode from 0.1 to 999 seconds
Interchangeable/replaceable focusing lenses in 3-, 5-, and 8-mm diameters	<ul style="list-style-type: none">Allows tailoring of the unit to your curing requirements
Instant on-off	<ul style="list-style-type: none">No warm-up periodMore energy efficient
Highly flexible interconnect cables with quick connect for LED heads	<ul style="list-style-type: none">Can be subjected to frequent movement, with small bend radiusFlexible cables are more resilient and pliable than typical lightguidesCan be daisy chained up to 10 m for separated workstationsEasy to handle and switch LED heads
Efficient LED-head temperature management	<ul style="list-style-type: none">Maximized continuous operation without overheatingComfortable hand-held operating temperature; no PPE requiredTemperature monitoring assures maximum LED life
PLC interface with 4-channel mode	<ul style="list-style-type: none">Easily incorporated into automated systems
Enhanced full touch screen HMI	<ul style="list-style-type: none">Easy to use, navigate and programRecipe storage for up to 20 programs
Cross platform compatibility	<ul style="list-style-type: none">LED heads are compatible with the BlueWave® MX-series multi-channel controllers when used with the MX-4E expansion module

Validation

Tests should be conducted prior to production to determine the time and light intensity required to fully cure your material. The following approaches may be used to validate the curing process.

Set Exposure Time, Determine Intensity

Users can specify a cure time and, through empirical testing, determine the intensity required to achieve a full cure. As with any manufacturing process, it is advisable to incorporate a safety factor.

Set Intensity, Determine Exposure Time

Users can specify light intensity and, through empirical testing, determine the exposure time required to achieve a full cure. As with any manufacturing process, it is advisable to incorporate a safety factor.

Control

Process validation confirms a minimum acceptable intensity. Users can then choose to operate at full intensity (using the excess intensity as an additional safety factor) or adjust the output to a specific intensity level. To ensure consistent and repeatable process results, intensity levels should be monitored with a radiometer. This enables users to identify light intensity changes and take corrective action (either adjusting the light intensity or performing maintenance).

Front LCD Panel





Control	Description
Front LCD Display	Displays the currently selected menu.
System Information	Used to check the version of the system and the accumulated usage time
System Setting	Used to set the configuration of the system, including language, brightness, and user initialization settings.
User Mode Setting	Toggles between ADMIN and PRODUCTION modes. ADMIN: The system default ADMIN interface. The user will have the highest authority and can modify the parameters of the light and system configuration. PRODUCTION: The PRODUCTION interface. The user can only modify the brightness of the screen. A password is needed to switch to the ADMIN interface.
Power Setting	Used to set the exposure power.
Timer Setting	Used to set the exposure time.
LED Head Type Indicators	Colored lights indicate the type of each connected LED head. A black light indicates the LED head type is VisiCure – 405 nm. A blue light indicates the LED head type is RediCure – 365 nm. A gray light indicates the LED head type is PrimeCure – 385 nm
Progress Bar Indicators	Indicates the current progress of each LED head.
Countdown Timer	Counts down from the setting time.
Single Channel Run/Stop Control	Each LED head can be run or stopped by pressing each channel icon of  and  separately.
All Channels Run/Stop Control	All LED heads can be run or stopped by pressing the icon of  or  .
Alarm Indicators	Indicates system faults.
Parameters Save/Load	Indicated the name of the current parameters setting.

Figure 2.

Front LCD Panel

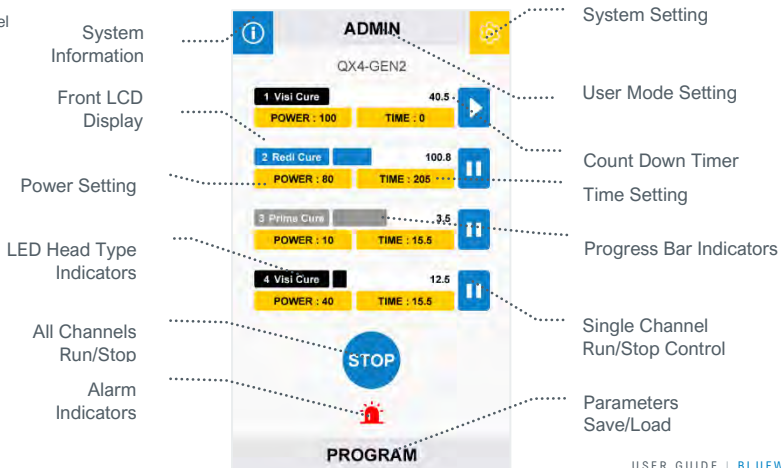

Back Panel

Component	Description
Power Cord Receptacle	Connection point for the power cord.
On/Off (I/O) Switch	Moving the switch to the on position (I) powers up the controller. Moving the switch to the off position (O) cuts power to the controller.
Footswitch Connection Jacks	Up to 4 footswitches can be used as optional irradiation triggers. Pressing the footswitch starts a curing cycle. In timed operation, pressing and releasing the footswitch initiates the curing cycle. Footswitch doesn't work until cycle ends.
PLC Connector Terminal	Connection points for interfacing with a user-supplied PLC. See the PLC Operation Section for more details.
RS232 Port	No functionality, provided for factory troubleshooting.
LED Head Connection Jacks	Connection points for up to four LED heads. Each connector corresponds to an available channel and indicator on the LCD display.

Figure 3.
Back Panel Controls & Connections

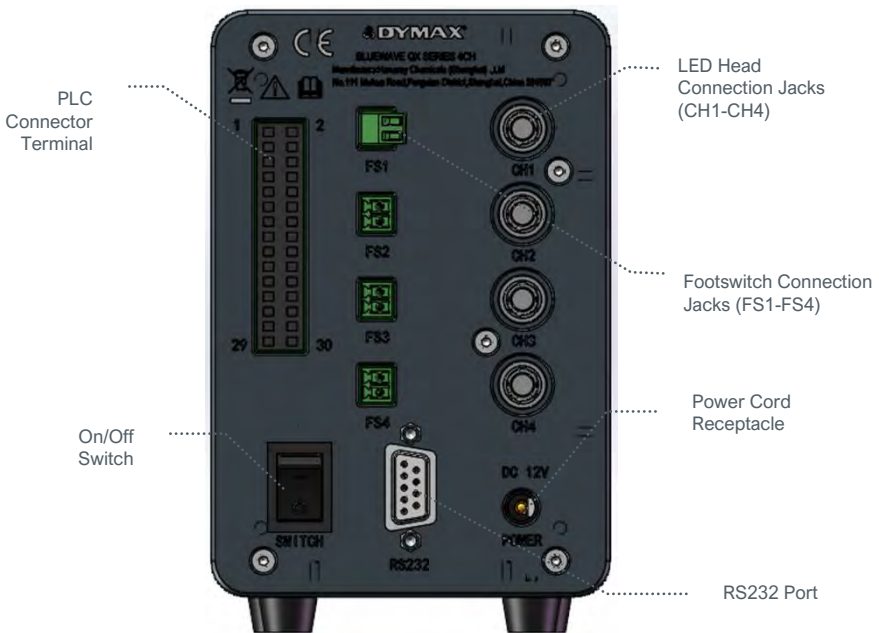

Unpacking

Upon arrival, inspect all boxes for damage and notify the shipper of box damage immediately. Open each box and check for equipment damage. If parts are damaged, notify the shipper and submit a claim for the damaged parts. Contact Dymax so that new parts can be shipped to you immediately.

The parts below are included in every package/order. If parts are missing, contact your local Dymax representative or Dymax Customer Support to resolve the problem.

Inspect the glass for any damage or residue on the surface. Carefully clean the glass with the alcohol swab. Take care not to touch the glass with bare hands, as any residue left on the window can adversely affect performance on the unit.

Parts Included

The following parts are included with your purchase configuration

Controller Kit

- BlueWave QX4 V2.0 4CH Controller
- Power Adapter
- Power Cord
- BlueWave QX4 V2.0 LED Spot-Curing System User Guide
- UV-Light Safety Guide (SAF001)
- Footswitch
- PLC Connection Terminal (attached in controller bag)
- Safety Eyewear

LED Heads

- BlueWave QX4 V2.0 LED Head Assembly (RediCure, PrimeCure, or VisiCure, model as selected at time of purchase)
- UV-Light Safety Guide (SAF001)

System Setup

System Connections

Power Cable Connection — Attach the Power Cord to the Power Cord Receptacle located on the unit's back panel (Figure 3). Press the Power Cord firmly into the receptacle until it clicks and locks into place. Insert the power cord to the Power Adapter socket, complete the connection of power transfer from 100-240Vac to 12Vdc for controller. Then, it is ready to be turned on with the On/Off Switch.

NOTE: To avoid loss of warranty and unit damage, use only Dymax supplied power adapter.

LED Head Connection Jacks — Along the right of the Controller's Rear Panel, there are four LED Head Connection Jacks labeled CH 1 - 4. The Connectors are keyed so they may require slight rotation to align with the keying elements of the connector pair.

Once the keyways are aligned, press the LED Head Connector into the Jack until it clicks and locks in place.

NOTE: DO NOT rotate the Connectors once installed, they are not threaded, and damage may occur.

To remove the LED Head, grasp the metal Outer Retaining Ring Body of the Connector and pull away from the Controller to unlock it from the Jack.

Footswitch Connection (Optional) — Located on the middle of the Controller's rear panel. It can be used as an optional irradiation trigger.

PLC Connection Terminals — There are input and output PLC Connection Terminals that can be used to integrate the unit to an automated assembly line. See the *PLC Operation Section* for more details.

A low signal (0V) input on PLC_ENABLE switches the QX4 to PLC mode. In PLC mode, the Front Control Display displays the PLC connection and locks out the screen input.

A high signal (24V) input on MASTER INTERLOCK locks out all the channel output.

Figure 4.

Components of a BlueWave QX4 V2.0 - Controller Kit
88823/88824/88825/88826/88828

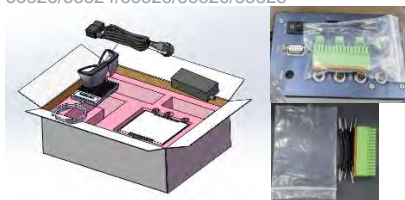

Figure 5.

Components of a BlueWave QX4 V2.0 - LED Head
88807/88808/88809



LED Heads & Lenses

The BlueWave QX4 V2.0 led heads are available in three different wavelengths: 365 nm (RediCure), 385 nm (PrimeCure), and 405 nm (VisiCure). Each LED head is made up of three main components: the handle, a collimating lens, and a focus lens. LED head assemblies are 1.0 M in length. Extensions can be purchased for extra length. Extension cables can be used for up to 10 meters additional length in any combination.

Figure 6.
LED Head Components



*Sold Separately

The wavelength of the LED head is noted on a label on handle. Collimating and focusing lenses on each LED head are interchangeable, but the handle is unique to a specific wavelength.

Figure 7.
Color-Coded LED Heads

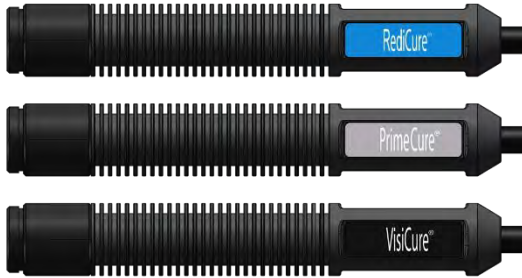

Label	Wavelength	Part Number
RediCure®	365 nm	88807
PrimeCure®	385 nm	88808
VisiCure®	405 nm	88809

Figure 8.
Focus Lenses (Sold Separately)



Focus Lens	Part Number
Φ 3 lens	81205
Φ 5 lens	81206
Φ 8 lens	81207

The focusing lenses indicate the spot sizes that are generated at a 5-mm working distance. The UV energy is focused on that spot and provides maximum output and uniformity of the spot.

As you change working distance, the intensity and spot size will change. It is best to review the product bulletin to ensure you are using the correct lens and working distance combination to achieve the target exposure.

If you are using larger working distances, you may have better results removing the focusing lens and using the collimating lens for spot generation.

Fixturing

If you are fixturing the LED head, do not cover the cooling fins, or overheating can result. We suggest clamping on the flat portion of the handle with non-marring screws or split ring clamps. We recommend using our mounting clamp kit (PN: 88821) for optimal support.

Figure 9.
Fixturing Recommendations

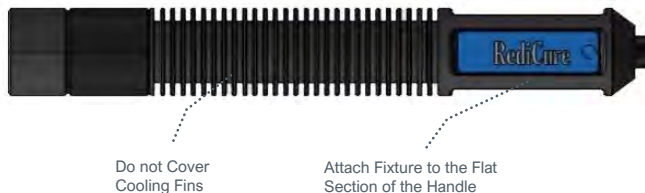

Operation

⚠ WARNING! Looking directly at the high-intensity light emitted by the heads of the BlueWave QX4 V2.0 can result in eye injury. To prevent eye injury, never look directly at the high-intensity light and always wear protective goggles (provided).

Verify that all connectors are firmly plugged into the rear panel of the unit. See *System Connections* for more details.

On the rear panel of the controller, move the Power Switch to the on position (I). The system is now ready for use.

On the first startup, the system defaults to ADMIN mode. The boot mode can be set through the User Interface in System Settings .

Figure 10.
Main Menu Screen in ADMIN Mode



Figure 11.
Return to ADMIN Mode by Entering the Password



ADMIN Mode

ADMIN mode allows the user to configure each LED head at a predefined (constant) power output for a given amount of time. Each head can be adjusted independently.

If the current mode is not ADMIN mode, you need to enter the password to return to the ADMIN mode.

Default Password:1234

Set Up

In the ADMIN mode menu, the user can see the current power and time configuration for each one of the LED heads. To update any LED head, navigate to the LED head by pressing the POWER or TIME icons. The selected option will open a value input window. Press the pad's button to edit. Any LED head that is not connected displays a N/A red icon. The user can still select and program any red-out rows, but the unit will not run the program for the disconnected LED head.

Another screen will show the power (Figure 13). Input the required power directly through the numeric keypad. The power can be set from a value of 10-100%, at 1% increments.

When editing is finished, press the return key in the upper left corner to go back to the ADMIN model menu.

Another screen will show the time (Figure 14). Input the required working time directly through the numeric keypad. The time can be set from a value of 0-999s.

When editing is finished, press the return key in the upper left corner to go back to the ADMIN model menu.

If the time is set to 0s, the LED head stays on until it is stopped manually.

Figure 12.
ADMIN Mode Menu



Figure 13.
Power Editing Screen



Figure 14.
Time Editing Screen



Irradiation

Once all the LED heads have been configured, press the run button to start irradiation of all LED heads, or press the right icon of each channel to ON/OFF separately.

The BlueWave QX4 V2.0 is rated for continuous operation. However, if the internal temperature of the system exceeds the maximum safe operating temperature limits, each LED head contains a thermal sensor that will shut the unit down to protect the components of the head.

During irradiation, the timer counts down to indicate the working time on the current curing session. Press the run button during an irradiation cycle to stop the irradiation and reset the cycle. The footswitch can also be used instead of pressing the run button.

PRODUCTION Mode

Set Up

Enter the PRODUCTION mode by pressing the ADMIN icon in ADMIN mode.

In PRODUCTION mode, all parameters are taken from the ADMIN mode, and no parameters are allowed to be modified.

You need to enter the password to return to the ADMIN mode from PRODUCTION mode.

Irradiation

Press the run button to start irradiation of all LED heads. To irradiate LED heads individually, press the run/stop button to the right of each channel to start and stop irradiation. In production mode, you cannot set power and curing time.

Figure 15.
Screen During Irradiation



PLC Operation

Programmable logic control (PLC) of the BlueWave QX4 V2.0 is achieved through the PLC terminal block connectors. The input connections are separated into two main groups: the exposure connections and the inhibit selection connections. PLC control is achieved via sinking I/O control pins. The input unit normally has high logic levels (+24V) and looks for a low signal (0V) input. The exposure connections can be used to activate specific heads or all heads simultaneously. The interlock and inhibit determine which channel will be shut off.

PLC operation mode can only be entered by short the PLC enable input to com (0V). This locks out the front control panel and prevents the user from entering any commands using the front buttons. **Programs and run modes must be adjusted prior to entering PLC mode.**

Figure 16. PRODUCTION Mode Menu



Figure 17. Screen During Irradiation

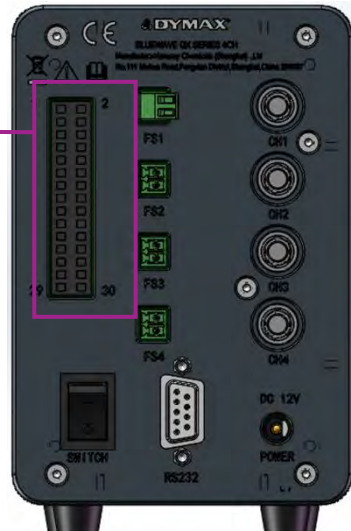

Figure 18. PLC Mode Screen



Figure 19. PLC Inputs & Outputs

PLC INTERFACE			
INPUT		OUTPUT	
1	PLC ENABLED	COM	2
3	EXPOSURE1	LED STATUS 1	4
5	EXPOSURE2	LED STATUS 2	6
7	EXPOSURE3	LED STATUS 3	8
9	EXPOSURE4	LED STATUS 4	10
11	EXPOSURE ALL	LED STATUS ALL	12
13	LED INHIBIT 1	OUTPUT RESERVE 3	14
15	LED INHIBIT 2	OUTPUT RESERVE 4	16
17	LED INHIBIT 3	OUTPUT RESERVE 5	18
19	LED INHIBIT 4	OUTPUT RESERVE 6	20
21	MASTER INTERLOCK	INTERLOCK STATUS	22
23	PROG/ANALOG	COM	24
25	ANALOG INTENSITY	COM	26
27	INPUT RESERVE	OUTPUT RESERVE 1	28
29	COM	OUTPUT RESERVE 1	30



PLC Mode Screen

The PLC Mode Screen appears when PLC mode is enabled. The display will provide status information in the form of colored bars.



INPUTS

Along the row of **INPUTS** are the Channel identifiers. Each connected head is indicated by an abbreviation.

Channel Abbreviation	Description
Redi	RediCure LED head connected
Prime	PrimeCure LED head connected
Visi	VisiCure LED head connected
NA	LED head is disconnected

INTRLK

The INTRLK (Interlock) status is indicated by a colored bar.

	Interlock Status
	Not Active
	Active

INHIBIT

The INHIBIT status is indicated by a colored bar.



	Inhibit Status
	Not Active
	Active

POWER

The LED head intensity setting.

LED ON



The START status shows channels that are actively irradiating.

	LED Head Irradiation Status
	Active
	Not Active

OUTPUTS



INTRLK

The INTRLK (Interlock) status is indicated by a colored bar.

	Interlock Status
	Not Active
	Active

WARNING

The WARNING signal is an indication of warning or activity.

	Warning Signal
	No Warning and Actively Irradiating
	Warning; Error



INHIBIT

The INHIBIT status is indicated by a colored bar.

	Inhibit Status
	Not Active
	Active

LED ON

The BUSY signal is indicated for head status activity.

	LED Head Irradiation Status
	Active
	Not Active

TIME

During irradiation, the time counts up to indicate the working time on the current curing session.

Figure 20.
Channel Identifiers



Figure 21.
Status Indicators



Example

In Figure 22, you will see that three channels have heads installed and their wavelength type.

CH1's interlock is not active, the LED is active.

CH2's interlock is not active, the LED is not active.

CH3's interlock is active, the LED is not active.

Figure 22.
Example Screen



Inputs

Signal Name/ Description	Asserted	Deasserted
	0V	24V
PLC ENABLE	The unit enters PLC mode. The front panel will display the PLC screen. The front panel will be locked. All PLC inputs will be monitored. All PLC Outputs will be active.	The unit enters normal mode. The front panel will be unlocked. All PLC Inputs will be ignored. All PLC Outputs will be inactive.
EXPOSURE 1->4	LED head "n" will turn on.	LED head "n" will turn off.
EXPOSURE ALL	All LED heads will turn on.	All LED heads will turn off.
INHIBIT 1->4	LED head "n" will function normally.	LED head "n" will turn off.
MASTER INTERLOCK	All LED heads will function normally.	Front panel displays lock screen. Front panel will be locked. All heads will be shut off.
PROG/ANALOG	Control the output power through the external analog signal.	Use the set power parameters on UI.
ANALOG INTENSITY	0-10V, DC input.	
INPUT RESERVE 1	Not used at this time	
COM	User signal ground	

Outputs

Note: Output pins require a 10K pull up resistor to customer supplied 24V depending on load, contact Application Engineering for issues related to choosing resistors.

Signal Name/ Description	Asserted	Deasserted
	0V	24V
LED STATUS 1 ->4	EXPOSURE 1->4 is asserted.	EXPOSURE 1->4 is de-asserted.
LED STATUS ALL	EXPOSURE ALL is asserted.	EXPOSURE ALL is de-asserted.
WARNING	Any LED head is in alarm or the controller is in alarm. Warning screen will be displayed. Front panel will be locked. All LED heads will be turned off. All LED heads will be disabled.	No LED heads or the controller are in alarm.
INTERLOCK STATUS	INTERLOCK Input is asserted.	INTERLOCK Input is de-asserted.
INHIBIT STATUS 1->4	INHIBIT 1->4 is asserted.	INHIBIT 1->4 is de-asserted.
COM	Reference Ground Pin	
OUTPUT RESERVE 1	Not used at this time	

Wiring PLC

The Input/Output terminal block and jumper wires are included in the packaging. Insert the terminal block on the controller. To enter PLC mode, short connect PLC Enabled (Pin1)] with COM (Pin2).

To control all channels together, short connect Exposure All (Pin11) with COM (Pin29), and short connect Master Interlock (Pin21) with COM (Pin24). Reserve COM (Pin26) for use with an extended jumper wire, to connect the COM to multiple LED Inhibit and Exposure pins.

To use selected channels, an extended jumper wire must be provided with a single point on one end and split up to eight points on the opposite end. Short connect COM (Pin26) with the extended jumper wire to LED Inhibit Pins 13/15/17/19 and Exposure LED1/2/3/4. To use an individual channel, an LED Inhibit Pin and Exposure Pin can be short connected. Example: Pin13 short connected and Pins 15/17/19 are left open when only using Exposure LED1.

PLC mode disables command and parameter settings from the HMI. Parameters can be set by the analog signal, by connecting Pins 23/25 and COM to an external analog controller.

Example Setup

The following is an example of how to set up the BlueWave QX4 V2.0 LED head controls to operate individually. (e.g. channel 1)

1. Set your individual LED head channels to the desired power level and exposure time using the touchscreen.
2. Connect an output of the PLC to PLC Enable (Pin1) and GND to Com (Pin2) of the BlueWave QX4 V2.0 PLC interface. This will put the controller into PLC control mode.
3. For one channel (e.g., channel1), connect other PLC outputs to the Pin3, Pin13, and Pin21.
4. To activate a channel, close the outputs following the pin order 1, 21,13, 3, and hold. The sink current required is approximately 10 mA.
5. Channels that have a preset time will count and then stop. Individual channels that have time set to zero, will only activate if the connection to the GND is applied. Throughout any exposure cycles, all channels will remain independent of each other so they can be activated in any sequence or order.

Figure 24.
Connection Diagram

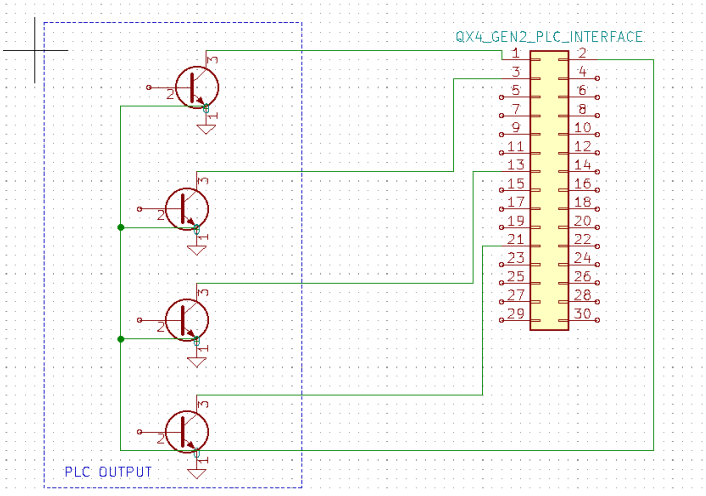
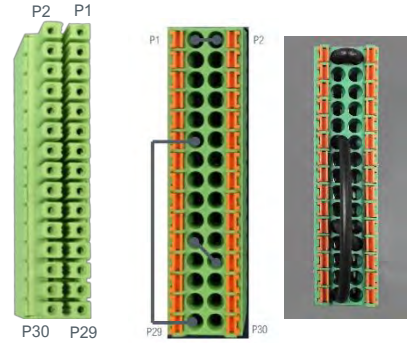

Figure 23.
PLC Plug (PN:84116), Attached to QX4 Controller in Packaging
Left: Rear Side, Right: Front Side



System Settings

System settings allow the user to change the language, sounds, and temperature warnings. To enter this menu, press top right corner icon of  to enter.

Setting the Language

To set the language, navigate to LANGUAGE in the settings adjustment screen. Select the language from the list of available languages and press back.

Figure 26.
Settings Screen

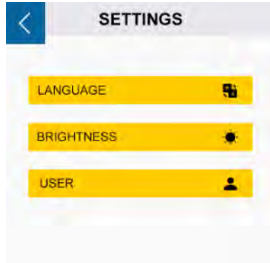

Figure 27.
Language Options Screen



Figure 25.
Select System Settings



Brightness Settings

To modify the brightness configuration, navigate to BRIGHTNESS on the settings adjustment screen (Figure 28). Set the desired brightness level, press DONE and back (Figure 29).

User Setting (Only in ADMIN Mode)

Press USER on the settings adjustment screen (Figure 28) to enter the user setting.

Select the Boot Mode.

Press "ADMINISTRATOR" or "PRODUCTION" button to select the boot mode. (Figure 30)

Press "DONE" button and power off the system. The machine will start in the selected mode when it's powered back up.

Figure 28.
Settings Adjustment Screen

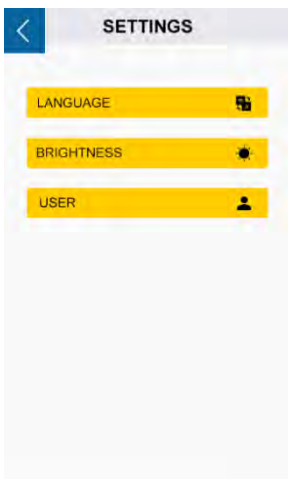
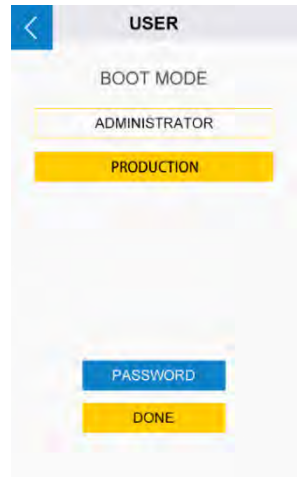

Figure 29.
Brightness Screen



Figure 30.
Boot Mode Screen



Change Your Password

The default password for administrator is “1234”.

1. Press the “PASSWORD” button on the user setting window (Figure 30).
2. Press the text input box and input the old password. (Figure 31)
3. Two new input fields will appear (Figure 32). Input your new password into both fields. Make sure they are same.
4. A message will appear confirming your setting is correct.

Figure 31.
Old Password



Figure 32.
New Password



System Information

The System information screen allow the user view information such as serial number, software version, and run hours of LED heads/wands. To enter this menu, press the top right corner icon  to enter.

Figure 33.
Main Menu Screen in ADMIN mode.



Figure 34.
System Information Screen

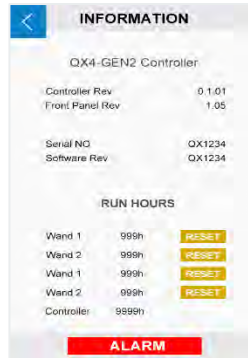

Reset the LED Head's Run Hours (Only in ADMIN Mode)

1. Press “RESET” to reset the LED run hours to 0 (Figure 34).
2. Press “Yes” to confirm. (Figure 35.)

Figure 35.
Confirm to Reset Run Hours



Note: Only clear the hours before you plug in a new LED head.

Check the Alarm Messages (Only in ADMIN Mode)

Press the Alarm Button (Figure 34) to check the history of alarm messages.

Only the controller and LED head over-temperature alarms can be reset.

Pressing the Reset Alarms Button (Figure 36) stops the unit's beeping and enables the LED head to run when the temperature is cold enough.

See "Alarm Messages Section" for alarm details.

Figure 36.
Alarm Messages

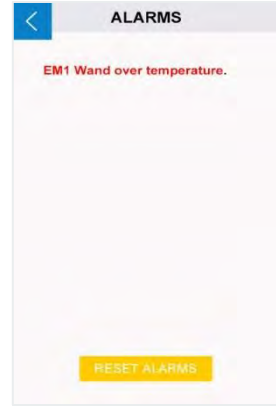

Cleaning & Maintenance

LED Head Optic Lens

Based on the cleanliness of your operating environment, establish a schedule for cleaning the LED-head lenses. When cleaning is required, shut the unit down and allow it to cool. When cool, clean the surfaces of the lenses with a clean, lint-free cloth.

Alarm Messages

The controller has 6 kinds of alarms to stop the machine. Each kind has its own error messages on the alarms screen.

Once a fault triggers the alarm, the LCD display switches to the cool-down screen (Figure 37). All the outputs are disabled and the controller beeps.

In ADMIN mode, you can enter the ALARMS window by pressing the red alarm icon.

Or you can power off the controller, then power up to enter the system information screen for it. (Figure 34)

Only the ADMIN mode has rights to check and reset alarms. The PRODUCTION mode has no rights to check or reset the alarms.

The user in the PRODUCTION mode should report alarms to the administrator immediately.

When the administrator arrives, the device should be powered off first.

After checking the connections and power, the administrator should check the alarm messages in the system information window. Then, the administrator should follow the suggestions in LCD error message indication to find solution.

Figure 37.
Cool-Down Screen (ADMIN MODE)

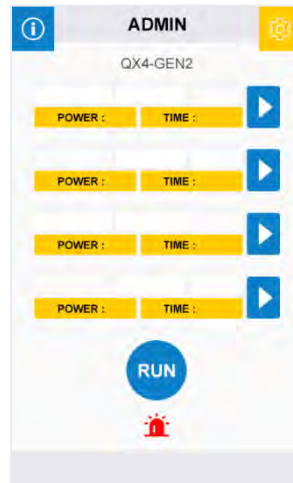

Figure 38.
Temperature Alarm Screen



Table 1.
LCD Alarm Message Indication

Message in Alarm	Trigger Condition	Suggestions
Ctrl Over Temperature.	The QX4_V2.0 controller internal temperature is higher than maximum.	<ul style="list-style-type: none"> The ambient temperature around the controller should not exceed 40°C. Check the controller's ventilation to cool down it.
EM x(1,2,3,4) wand not installed.	The LED head is not connected correctly.	Check the connections of the LED heads and reinstall the LED heads.
Ctrl Voltage abnormal.	The input voltage is too low.	Check the power input connection and power adapter.
EM x(1,2,3,4) wand over temperature.	The LED PCB temperature is over 69°C	<ul style="list-style-type: none"> The ambient temperature around the LED Heads should not exceed 40°C Check the LED heads' ventilation to cool down it.
EM x(1,2,3,4) wand over current.	The LED head's output current is over maximum.	Contact Dymax for technical support.
EM x(1,2,3,4) wand output not match setting.	The LED head's output current is 0A.	Contact Dymax for technical support.

Troubleshooting

Table 2.
Troubleshooting Chart for BlueWave LED QX4 V2.0

Problem	Possible Cause	Corrective Action
BlueWave QX4 V2.0 does not power up	Power cord not plugged in or damaged	Check power connection and condition at power supply "brick" and controller.
	No electrical power at receptacle	Test receptacle for power.
BlueWave QX4 V2.0 powers up but the LED head does not produce light	LED intensity adjustment set to 0%	Increase LED intensity setting.
	Interface cable connections loose or damaged	Check connections and condition of interface cable.
	LED head is not connected to the correct port/channel	Verify that the head is connected to the desired port/channel.
BlueWave QX4 V2.0 is operating normally, and the head suddenly stops producing light. The controller beeps. The LCD display locks.	Over temperature alarms	Follow the error messages section to handle.
LED head provides only low-intensity light	LED intensity adjustment set to minimum	Increase LED intensity setting.
	Contaminated/dirty lens optics	Clean the surface of the lens.
Footswitch does not function	Footswitch not connected	Connect footswitch.
	Footswitch is not connected to the correct port/channel	Verify that the footswitch is connected to the desired port/channel.
	Footswitch defective	Activate unit using the front control panel. Replace the footswitch if the unit operates from the front control panel.

Spare Parts and Accessories

Item	Part Number
Key System Components	
AC Power Adapter	84103
Controller NA Power Cord (Type B)	88824
Controller China Power Cord (Type I)	88823
Controller Europe Power Cord (Type F)	88825
Controller UK/Asia Power Cord (Type G)	88826
Footswitch (Optional)	84124
LED Heads, 1.0 meter	
RediCure 365 nm	88807
PrimeCure 385 nm	88808
VisiCure 405 nm	88809
Lens, Focusing	
ø3 mm, Spot	81205
ø5 mm, Spot	81206
ø8 mm, Spot	81207
Angle Adapters	
90° Angle Adapter for LED Head	81209
Extension Cables	
Connection Cable, 1.0 M Extension	84125
Connection Cable, 2.0 M Extension	84127
Power Cords	
Power Cord, North America (Type B)	84123
Power Cord, China (Type I)	84104
Power Cord, Europe (Type F)	84120
Power Cord, UK/Asia (Type G)	84121
PLC	
Controller Terminal	84116
Personal Protection Equipment	
Protective Goggles — Green	35286
Protective Goggles — Gray (standard model included with unit)	84126
Face Shield	35186
Radiometer	
Dymax ACCU-CAL™ 50-LED Radiometer (spot)	40505
BlueWave QX4 Adapter Upgrade Kit (For customers who already own an ACCU-CAL 50-LED radiometer) <i>Includes the integrated optic adapter, upgraded internal software, & calibration.</i> <i>Note: Your ACCU-CAL 50-LED must be returned to Dymax for programming.</i>	42218
Stands And Protection	
QX4 V2.0 Mounting Clamp Set (including 81016)	88821
Mounting Clamp Extend Rod Kit	88822
3-Sided Acrylic Shield	81016

Specifications



Property	Specification		
LED Head	RediCure	PrimeCure	VisiCure
Part Number	88807	88808	88809
Intensity Output*	16.9 W/cm ²	22.9 W/cm ²	22.0 W/cm ²
Output Frequency	365 nm	385 nm	405 nm
Power Supply Input	100-240 V ~ 1 A, 50/60 Hz		
LED Timer	0.1 to 999 seconds		
LED Activation	Footswitch, front panel, or PLC		
Cooling	Natural convection		
Controller Dimensions	147.5 mm x 93.5 mm x 137.4 mm (D x W x H)		
LED Head Dimensions	See Figure 40		
Weight	Controller: 2.2 lbs. [1. kg] / Head: 4.6 oz [130 g]		
Unit Warranty	1 year from purchase date		
Operating Environment	10 - 40°C, 0-80% relative humidity, non-condensing		

*Measured with 3-mm lens using Dymax ACCU-CAL™ 50-LED Radiometer, in spot mode at a distance of 5 mm.

Figure 39.
BlueWave QX4 V2.0 Spectral Output

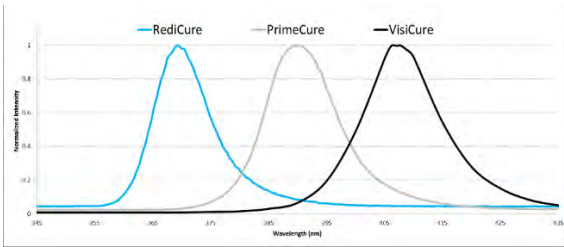

Figure 40.
Dimensions - LED Heads (PN:88807/88808/88809)



Figure 41.
Focus Lens Dimensions

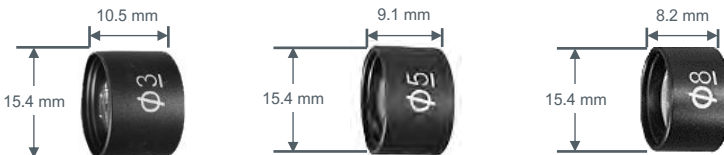
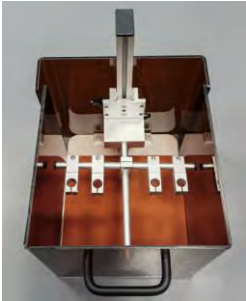

Figure 42.
Dimensions – Controller (PN: 88806)



Figure 43.
LED Head Mounting Stand (PN: 88821)



Declaration of Conformity

Figure 44.
Declaration of Conformity - CE

EU Declaration of Conformity

Manufacture:
Hanarey Chemicals (Shanghai) Co., Ltd.
No. 111 Muhua Road, Fengxian District,
Shanghai, China 201507

Product description: UV Spot Curing Device
Model name(s): **BlueWave QX4 V2.0 Controller**
BlueWave QX4 V2.0 Wand RediCure/ PrimeCure/ VisiCure

This product complies with the following relevant Union Harmonization Legislation:

Electromagnetic Compatibility Directive (2014/30/EU): EN 61000-6-3:2009 + A1:2011 EN IEC 61000-3-2:2019 EN 61000-3-3:2013+A1:2019 EN IEC 61000-6-1:2019	Low Voltage Directive (2014/35/EU): EN 61010-1:2010-A1:2019 EN 62471:2008
--	--

RoHS Directive 2011/65 EU (Incl. (EU) 2015/863)
EN IEC 63000:2018

Declaration:
This declaration of conformity is issued under the sole responsibility of the manufacturer.
Signed for and on behalf of Hanarey Chemicals (Shanghai) Co., Ltd.

 Name	 Date	 Location	
--	--	--	--

Authorized Signatory:
Kyle Zhu
Senior Manager, Equipment Development
Hanarey Chemicals (Shanghai) Co., Ltd.

www.dymax.com

North America: +1 860.482.1010 | Europe: +49 611 962.7900 | Asia: +65 67622887

© 2021 Dymax Corporation. All rights reserved. All trademarks are the property of their respective owners. All other trademarks are the property of their respective owners. Dymax Corporation, 111 Muhua Road, Fengxian District, Shanghai, China 201507. **Provision that most of operating and using system applications are safety.** Dymax does not warrant the accuracy of the information provided in this document. Any warranty applicable to the product is applicable and users should refer to the user manual for the product. Dymax does not warrant the accuracy of the information provided in this document. Any warranty applicable to the product is applicable and users should refer to the user manual for the product. Dymax does not warrant the accuracy of the information provided in this document. Any warranty applicable to the product is applicable and users should refer to the user manual for the product. Dymax does not warrant the accuracy of the information provided in this document. Any warranty applicable to the product is applicable and users should refer to the user manual for the product.

Figure 45.
Declaration of Conformity – UK CA



UK Declaration of Conformity

Manufacturer:
 Hanarey Chemicals (Shanghai) Co., Ltd.
 No.111 Muhua Road, Fengxian District,
 Shanghai, China 201507

Product description:
 Model name(s):

UV Spot Curing Device
BlueWave QX4 V2.0 Controller
BlueWave QX4 V2.0 Wand RediCure/ PrimeCure/ VisiCure

This product complies with the following relevant UK Legislation:

<p>Electromagnetic Compatibility Regulation 2016: EN 61000-6-3:2007+A1:2011 EN IEC 61000-3-2:2019 EN 61000-3-3:2013+A1:2019 EN IEC 61000-6-1:2019</p>	<p>Electrical Equipment (Safety) Regulations 2016: EN 61010-1:2010-A1:2019 EN 62471:2006</p>
--	---

**The Restriction of the Use of Certain Hazardous Substances
 in Electrical and Electronic Equipment Regulation 2012**
 EN IEC 63000:2018

Declaration:
This declaration of conformity is issued under the sole responsibility of the manufacturer.
 Signed for and on behalf of Hanarey Chemicals (Shanghai) Co., Ltd

 Name	2021. 9. 23 Date	Shanghai Location
---	---------------------	----------------------



Authorized Signatory:
 Kyle Zhu
 Senior Manager, Equipment Development
 Hanarey Chemicals (Shanghai) Co., Ltd.



www.dymax.com

North America: +1 860 482.1010 | Europe: +49 611 962.7900 | Asia: +65 67522887

© 2021-2022 Dymax Corporation. All rights reserved. All trademarks are the property of their respective owners. All products of Dymax are made in the USA.
 Please note that most equipment and curing system applications are in-line. Dymax does not warrant or endorse the use of its products for off-line applications. Any warranty applicable to the products in agriculture and any liability limited by the manufacturer Dymax's standard Conditions of Sale. Dymax recommends that any in-line application be evaluated and tested by the user or manufacturer to verify performance results are satisfied. Dymax's liability is limited to the extent of the performance warranty and includes, by way of limitation, the general fit, finish and factory programs to assist in each facility and installation. Data sheets are available for other countries to produce your local copy.

Warranty

From date of purchase, Dymax Corporation offers a one-year warranty against defects in material and workmanship on all system components with proof of purchase and purchase date. Unauthorized repair, modification, or improper use of equipment may void your warranty benefits. The use of aftermarket replacement parts not supplied or approved by Dymax Corporation, will void any effective warranties, and may result in damage to the equipment.

IMPORTANT NOTE: *DYMAX CORPORATION RESERVES THE RIGHT TO INVALIDATE ANY WARRANTIES, EXPRESSED OR IMPLIED, DUE TO ANY REPAIRS PERFORMED OR ATTEMPTED ON DYMAX EQUIPMENT WITHOUT WRITTEN AUTHORIZATION FROM DYMAX. THOSE CORRECTIVE ACTIONS LISTED ABOVE ARE LIMITED TO THIS AUTHORIZATION.*

Index

- ADMIN Mode, 10
- Alarms, 18
- Back Panel Controls, 7
- Connections, 8
- Declaration of Conformity, 23
- Features and Benefits, 5
- Focusing Lenses, 9
- Front LCD Panel, 6
- Help & Support, 4
- LED Heads, 9
- Lens Cleaning, 18
- Operation, 10
- PLC, 12
 - Inputs, 14
 - Outputs, 14
 - Wiring, 15
- Product Overview, 5
- Production Mode, 11
- Safety, 4
- Settings, 16
 - Brightness, 16
 - Language, 16
 - Password, 17
 - User Settings, 16
- Setup, 8
- Spare Parts & Accessories, 20
- Specifications, 21
 - Dimensions, 21
 - Spectral Output, 21
- System Information, 17
- Troubleshooting, 19
- Unpacking, 8
- Validation, 6
- Warranty, 25

Manufacturer

Hanarey Chemicals (Shanghai) Co., Ltd.
No.111 Muhua Road,
Fengxian District,
Shanghai, China 201507

Sales Representatives

<u>North America:</u>	<u>Europe:</u>	<u>United Kingdom:</u>	<u>Asia & Pacific:</u>
Dymax Corporation 318 Industrial Lane Torrington, CT 06790, USA	Dymax Europe GmbH Kasteler Str. 45 Geb. G359 Wiesbaden, Germany 65203	Kelvin Westscott 1b Hunts Grove Drive, Hardwick, Gloucester, Gloucestershire, GL2 4BH United Kingdom	Dymax Asia Pacific Pte Ltd Block 5008, Ang Mo Kio Ave 5, #05-03, Techplace Singapore 569874

Note:

Hanarey global sales representatives take the obligations of importers also.



www.dymax.com

North America: +1 860.482.1010 | Europe: +49 611.962.7900 | Asia: +65.67522887

© 2021-2023 Dymax Corporation. All rights reserved. All trademarks in this guide, except where noted, are the property of, or used under license by Dymax Corporation, U.S.A.

Please note that most dispensing and curing system applications are unique. Dymax does not warrant the fitness of the product for the intended application. Any warranty applicable to the product, its application and use is strictly limited to that contained in Dymax's standard Conditions of Sale. Dymax recommends that any intended application be evaluated and tested by the user to ensure that desired performance criteria are satisfied. Dymax is willing to assist users in their performance testing and evaluation by offering equipment trial rental and leasing programs to assist in such testing and evaluations. Data sheets are available for valve controllers or pressure pots upon request. MAN119DA 6/5/2024