



# ACCU-CAL™ 50-LED

LED Radiometer User Guide





## About Dymax

UV/Visible light-curable adhesives. Systems for light curing, fluid dispensing, and fluid packaging.

Dymax manufactures industrial, light-curable, epoxy, and activator-cured adhesives. We also manufacture a complete line of manual fluid dispensing systems, automatic fluid dispensing systems, and light-curing systems. Light-curing systems include LED light sources, spot, flood, and conveyor systems designed for compatibility and high performance with Dymax adhesives.

Dymax adhesives and light-curing systems optimize the speed of automated assembly, allow for 100% in-line inspection, and increase throughput. System designs enable stand-alone configuration or integration into your existing assembly line.

Please note that most dispensing and curing system applications are unique. Dymax does not warrant the fitness of the product for the intended application. Any warranty applicable to the product, its application, and use is strictly limited to that contained in the Dymax standard Conditions of Sale. Dymax recommends that any intended application be evaluated and tested by the user to ensure that desired performance criteria are satisfied. Dymax is willing to assist users in their performance testing and evaluation by offering equipment trial rental and leasing programs to assist in such testing and evaluations. Data sheets are available for valve controllers or pressure pots upon request.

# Contents

<b>Introduction</b> .....	<b>4</b>
<b>Safety</b> .....	<b>4</b>
General Safety .....	4
Safety .....	4
<b>Product Overview</b> .....	<b>5</b>
<b>Installation</b> .....	<b>6</b>
Unpacking and Inspecting Your Shipment.....	6
Parts List - Spot & Line Array Configuration.....	6
Parts List - Flood Configuration .....	6
<b>Operation</b> .....	<b>7</b>
Testing a Flood Lamp System .....	7
Testing Spot Lamp Systems .....	8
Testing the BlueWave® QX4 .....	10
<b>Maintenance</b> .....	<b>12</b>
<b>Spare Parts and Accessories</b> .....	<b>13</b>
<b>Specifications</b> .....	<b>13</b>

# Introduction

The enclosed ACCU-CAL™ 50-LED Radiometer was developed and manufactured by the Dymax team, driven by a desire to best serve your needs. Before shipping, your ACCU-CAL™ 50-LED Radiometer was calibrated and tested against standard LED light sources to ensure accurate performance.

The operation of this radiometer in conjunction with an LED light-curing system will maximize safety and user-friendly performance and provide optimum yield of your technological process.

Therefore, we encourage you to read, understand, and follow all safety and operating instructions and recommendations compiled in this and other related manuals prior to setting up and operating this instrument and any associated light-curing systems.

If you encounter a problem, have any questions, or would like to help us with your suggestions or recommendations, please contact our Technical or Customer Service Departments at 860-482-1010. Trained Dymax professionals are standing by to serve you.

Par conséquent, nous vous encouragez à lire, comprendre, et suivre toute sécurité et instructions d'opération et conseils rédigés dans cette et autres manuels établis avant de mettre en place et de faire fonctionner ce nouveau système de lampe de tache ou ces composants individuels.

Si vous rencontrez un problème, avez n'importe quelles questions, ou si vous voudrez de nous aider avec vos suggestions ou conseils, s'il vous plaît contactez notre département technique ou service client à 860-482-1010. Dymax formés professionnels attendent de vous servir.

## Safety

### General Safety

Before continuing, please read the following chapters of this manual for safety recommendations and installation, running, and troubleshooting instructions.



**CAUTION!** Always wear protective goggles or a face shield when working near the front of any unit which emits UV light! The rear of some units also emits stray UV light.

**WARNING!** Always observe safety requirements!

**PRÉ-CAUTION!** Toujours faire de l'usage des lunettes de protection ou protéger de visage marche près du devant d'élément!

**PRÉ-CAUTION!** Risque de décharge électrique quand le couvercle est enlevé!

**ACHTUNG!** Tragen Sie immer eine Sicherheitsbrille oder einen Gesichtsschutz, wenn Sie nahe an der UV Lichtquelle arbeiten. Die Rückseite des Gerätes emittiert gestreutes UV Licht!

**WARNHINWEIS!** Bitte beachten Sie immer die Sicherheitshinweise!

## Safety

The ACCU-CAL™ 50-LED Radiometer is designed to be used in conjunction with Dymax LED curing equipment that is properly set up, with components correctly connected, and operated in accordance with relevant instructions.

### Safety Recommendations

- When working with UV or visible light sources, use goggles (provided) or a face shield approved for UV protection to protect your eyes.
- Long-sleeved shirts or a lab coat are recommended to protect the arms, and use of UV opaque gloves will protect the hands.

## Sécurité

L'équipement est conçu pour être utilisé correctement, avec les composants branchés correctement, et utilisé conformément aux instructions importantes. Le plan était de développer pour rendre au maximum l'opérateur sûr et minimiser l'exposition à l'ultraviolet.

## Recommander de sécurité

- Emploi lunettes, ou un protègeur de visage pour protection de ultraviolet pour protéger vous yeux.
- Chemises à manche long, ou manteau de labo, sont recommander pour protéger les bras, et utilisation de ultraviolette gants opaque vais protéger les mains.

## Sicherheitshinweise

Dieses Gerät wurde so entwickelt, dass es nur vollständig, alle Komponenten korrekt miteinander verbunden, in Übereinstimmung mit relevanten Instruktionen betrieben wird. Bei der Entwicklung wurde weiterhin großen Wert auf die Benutzersicherheit und minimale UV Belastung gelegt.

### Sicherheitshinweise

- Tragen Sie immer die mitgelieferten Sicherheitsbrille oder speziellen Gesichtsschutz, der Ihre Augen vor UV Licht schützt.
- Wir empfehlen Langarm - Hemden oder einen Laborkittel zu tragen, um die Arme zu schützen. Für die Hände empfehlen wir UV- geblockte Handschuhe.

## Product Overview

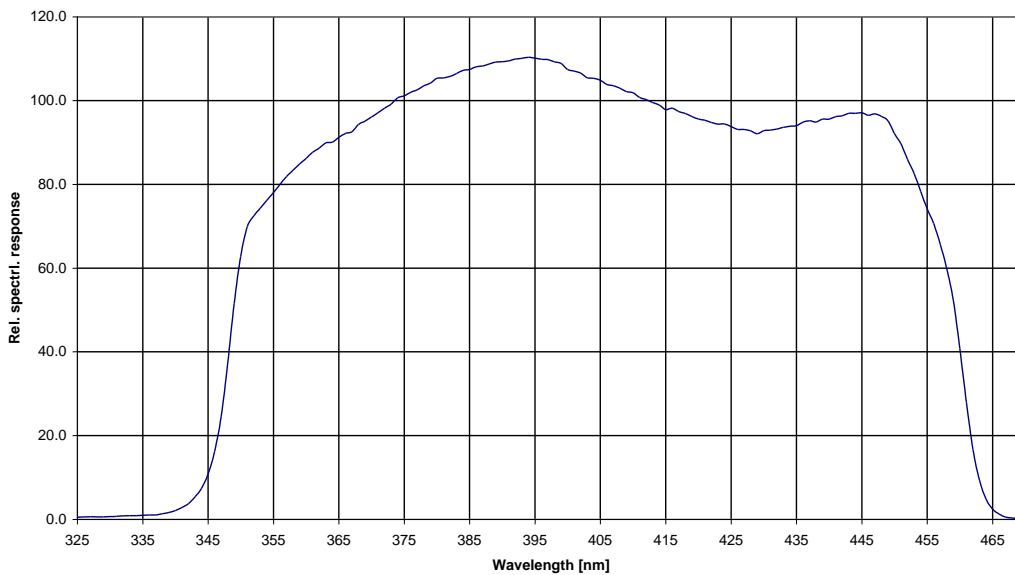
The ACCU-CAL™ 50-LED Radiometer is a microprocessor-based measurement instrument designed to measure curing-energy radiation in the range of 350 - 450 nm.

The ACCU-CAL™ 50-LED uses two AA batteries.

### Environmental Considerations

- Optical measurement instruments are sensitive to extremes in environmental conditions like high temperature, humidity, and contamination. Protect the device and its detector(s) from high humidity, high temperature, direct sunlight, and contamination.
- Do not use the ACCU-CAL™ 50-LED Radiometer immediately after moving it from a cold to a warm environment. Under certain circumstances, condensation could develop that may cause inaccurate measurement results. Allow the device to adjust to room temperature before use.
- Do not use the ACCU-CAL™ 50-LED Radiometer in powerful magnetic, electromagnetic, or electrostatic fields. These disturbances may influence measurement results.

Figure 1.  
ACCU-CAL™ 50-LED Spectral Response Curve



# Installation

## Unpacking and Inspecting Your Shipment

When your radiometer arrives, inspect the box and immediately notify the shipper of any damage.

Open the box and check for equipment damage. If parts are damaged, notify the shipper and submit a claim for the damaged parts. Contact Dymax so that new parts can be shipped to you immediately.

Check that the parts included in your order match those listed below. If parts are missing, contact your local Dymax representative or Dymax Customer Support to resolve the problem.

**Figure 2.**  
ACCU-CAL™ 50-LED Radiometer  
(PN 40505) for Spot, Line, & Flood Lamps



**Figure 3.**  
ACCU-CAL™ 50-LED Radiometer (PN 40519) for  
Flood Lamps Only



### Parts List - Spot & Line Array Configuration

- ACCU-CAL 50-LED Radiometer
- ACCU-CAL 50-LED Radiometer User Guide
- 3-mm, 5-mm, 8-mm Lightguide Adapters
- Optic Adapter for the BlueWave QX4
- Line-Array Adapter
- Lightguide Simulator (PN 38408)
- 2-mm Hex Wrench
- Spare 2-mm Adapter Screws

### Parts List - Flood Configuration

- ACCU-CAL 50-LED Radiometer
- ACCU-CAL 50-LED Radiometer User Guide



# Operation

The ACCU-CAL™ 50-LED Radiometer may be used to measure intensity from LED-type flood, line array, or spot sources. Instructions for use with each system type are below.

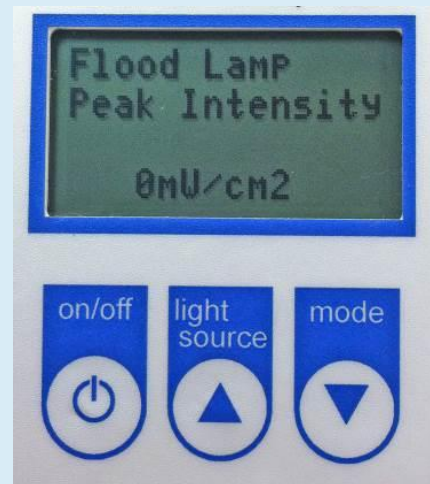
## Testing a Flood Lamp System

1. Attach the detector to the radiometer (Figure 4). Do not attach any lightguide adapters to the detector.
2. Press and release the On/Off button on the radiometer's face plate to turn the unit on.
3. On the radiometer's display, the top line displays the light source and the second line displays the mode.
4. Press and release the Light Source button to select the light source being measured. Repeatedly press the button until "Flood Lamp" appears on the top line of the display (Figure 5).
5. Press and release the Mode button to select the operating mode. Repeatedly press the Mode button until the mode you desire appears on the second line of the display. The different operating modes are:
  - **Peak Intensity** - Shows the highest intensity in  $\text{mW}/\text{cm}^2$  seen by the detector during the measurement and stores that value in the display.
  - **Intensity** - Shows the intensity in  $\text{mW}/\text{cm}^2$  at the detector during the measurement. This is a dynamic readout of intensity.
  - **Dose** - Shows the total energy dose in  $\text{mJ}/\text{cm}^2$  at the detector during the measurement.  
*Note: This measurement is time dependent.*
6. Place the end of the Detector under an operating flood lamp, ensuring that the detector sensing window is facing the light source.

**Figure 4.**  
Attach Detector to Radiometer



**Figure 5.**  
Flood Source Screen  
(Shown in Peak Intensity Mode)



## Testing Spot Lamp Systems

1. Attach the detector to the radiometer (Figure 6).
2. Select the lightguide adapter that matches the size of the spot lamp's lightguide. 3, 5, and 8-mm lightguide adapters are supplied with the radiometer.
3. Install the lightguide adapter on the end of the detector using the two 2-mm adapter screws provided (Figure 7).
4. Insert the lightguide into the lightguide adapter until it bottoms out. Tighten the set screw when the lightguide is installed.

*Note: Do not over-tighten the set screw, as damage to the lightguide may occur.*

7. Press and release the On/Off button on the radiometer's face plate to turn the unit on.
8. On the radiometer's display, the top line displays the light source and the second line displays the mode.
9. Press and release the Light Source button to select the light source being measured. For spot lamps, use the lightguide setting. Repeatedly press the Light Source button until the correct lightguide size appears on the top line. The options are:
  - **3-mm Lightguide** - For use when measuring energy at the end of a 3-mm lightguide.
  - **5-mm Lightguide** - For use when measuring energy at the end of a 5-mm lightguide.
  - **8-mm Lightguide** - For use when measuring energy at the end of an 8-mm lightguide.

10. Press and release the Mode button to select the operating mode. Repeatedly press the Mode button until the mode you desire appears on the second line of the display. The different operating modes are:
  - **Peak Intensity** - Shows the highest intensity in  $\text{mW}/\text{cm}^2$  seen by the detector during the measurement and stores that value in the display.
  - **Intensity** - Shows the intensity in  $\text{mW}/\text{cm}^2$  at the detector during the measurement. This is a dynamic readout of intensity.
  - **Dose** - Shows the total energy dose in  $\text{mJ}/\text{cm}^2$  at the detector during the measurement.

*Note: This measurement is time dependent.*

11. Turn on the spot lamp to begin testing.

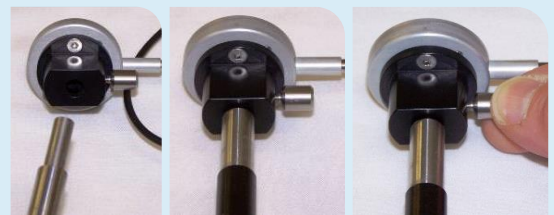
**Figure 6.**  
Attach Detector to Radiometer



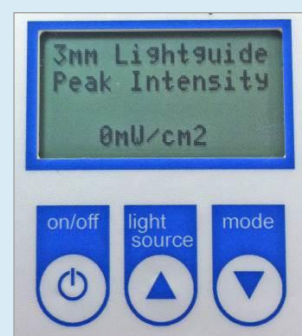
**Figure 7.**  
Adapter Installation



**Figure 8.**  
Attach Lightguide Adapter to Lightguide (Step 4)



**Figure 9.**  
Lightguide Source Screen  
(3 mm Shown in Peak Intensity Mode)





## Testing a Line Array System

1. Attach the detector to the radiometer (Figure 10).
2. Select the line array adapter.
3. Install the line array adapter onto the detector face using the two 2-mm screws provided (Figure 12).

*Note: Do not over-tighten the set screw, as damage to the lightguide may occur.*

4. Press and release the On/Off button on the radiometer's face plate to turn the unit on.
5. On the radiometer's display, the top line displays the light source and the second line displays the mode.
  - Repeatedly press and release the Light Source button until "Line Array" is displayed in the top line of the display.
6. Press and release the Mode button to select the operating mode. Repeatedly press the Mode button until the mode you desire appears on the second line of the display. The different operating modes are:
  - **Peak Intensity** - Shows the highest intensity in  $\text{mW}/\text{cm}^2$  seen by the detector during the measurement and stores that value in the display.
  - **Intensity** - Shows the intensity in  $\text{mW}/\text{cm}^2$  at the detector during the measurement. This is a dynamic readout of intensity.
  - **Dose** - Shows the total energy dose in  $\text{mJ}/\text{cm}^2$  at the detector during the measurement.

*Note: This measurement is time dependent.*

### Taking Measurements

- Static readings for general process control when emitter and target are fixed and working distances are greater than 0 mm:
  1. Using a fixed location in the field of the array emissions, place the aperture of the adapter as close to center as allowable.

*Note: Repeatable placement is key to getting consistent readings at working distances beyond direct measurement at the emitter face. An alignment fixture can help ensure accuracy at these working distances.*

**Figure 10.**  
Attach Detector to Radiometer



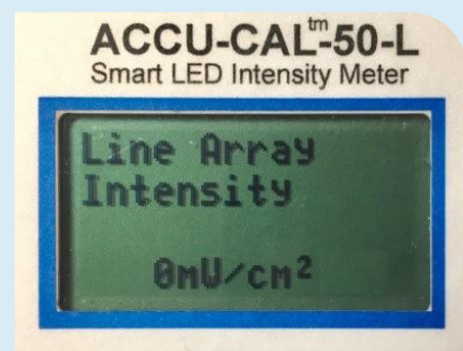
**Figure 11.**  
Line Array Adapter



**Figure 12.**  
Adapter Installation

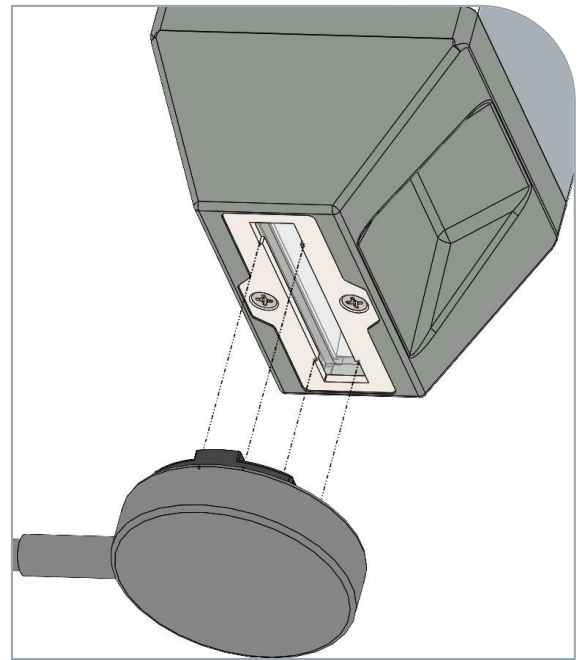


**Figure 13.**  
Line Array Source Screen  
(Shown in Intensity Mode)



2. Select the measurement mode appropriate for the data required and take readings. To improve accuracy, it is suggested that multiple measurements be taken and averaged.
- Direct readings at 0-mm working distance for repeatable measurements:
    1. With the adapter installed, align the radiometer sensor by nesting the emitter faceplate onto the adapter tabs to ensure precise engagement (Figure 14).
    2. Keep the sensor and emitter square to each other and activate an exposure cycle of the emitter.
    3. Take intensity reading after 5-10 seconds to allow for output stabilization.
    4. To avoid possible damage to the radiometer sensor, allow the sensor to cool between measurements and do not expose the sensor to energy emissions for more than 15 seconds.

**Figure 14.**  
Adapter Alignment



## Testing the BlueWave® QX4

1. Attach the detector to the radiometer (Figure 15).
2. Attach the BlueWave QX4 optic adapter to the detector (Figure 16) using the two 2-mm screws provided.

*Note: The optical adapter and optometer are calibrated as a set, so they are not interchangeable among other similar type radiometers.*

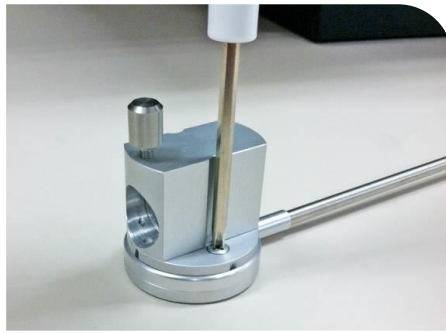
3. Insert the LED head into the optic adapter until it bottoms out. Tighten the set screw on the top of the optic adapter when the LED head is installed.

*Note: Do not over tighten the set screw, as damage to the LED head may occur.*

**Figure 15.**  
Attach Detector



**Figure 16.**  
Attach Optic Adapter to Detector



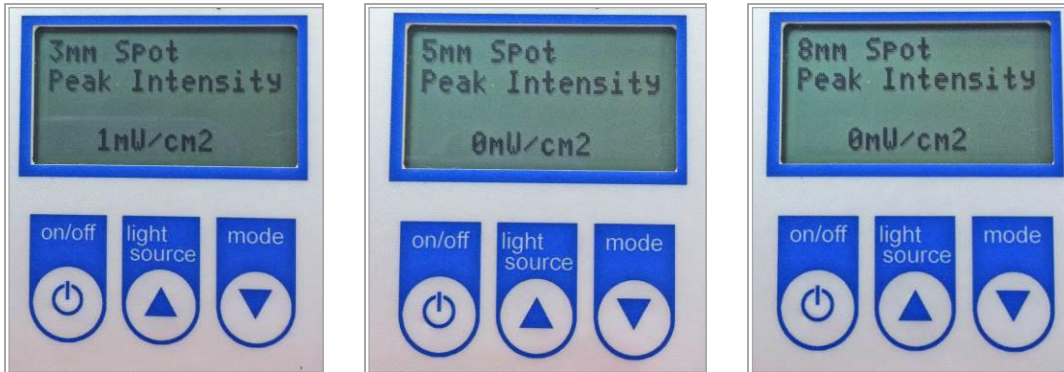
**Figure 17.**  
Insert LED Head into Optical Adapter



4. Press and release the On/Off button on the radiometer's face plate to turn the unit on.
5. On the radiometer's display, the top line displays the light source and the second line displays the mode.

6. Press and release the Light Source Button to select the light source being measured. For the BlueWave QX4, use the “spot” setting. Repeatedly press the Light Source Button until the correct focus lens size appears on the top line. The options are:
- **3-mm Spot** - For use when measuring a BlueWave QX4 LED head with the 3-mm focus lens installed
  - **5-mm Spot** - For use when measuring a BlueWave QX4 LED head with the 5-mm focus lens installed
  - **8-mm Spot** - For use when measuring a BlueWave QX4 LED head with the 8-mm focus lens installed

**Figure 18.**  
Spot Mode Screens (Shown in Peak Intensity Mode)



7. Press and release the Mode button to select the operating mode. The different operating modes are:
- **Peak Intensity** - Shows the highest intensity in  $\text{mW}/\text{cm}^2$  seen by the detector during the measurement and stores that value in the display.
  - **Intensity** - Shows the intensity in  $\text{mW}/\text{cm}^2$  at the detector during the measurement. This is a dynamic readout of intensity.
  - **Dose** - Shows the total energy dose in  $\text{mJ}/\text{cm}^2$  at the detector during the measurement.

*Note: This measurement is time dependent.*

8. Turn on the BlueWave QX4 to begin testing.

# Maintenance

The ACCU-CAL™ 50-LED was designed to operate with minimum maintenance. Follow the schedule below to assure top unit performance.

- Calibrate the instrument at least annually. Calibration service is available through Dymax Customer Service or Dymax Product Repair.
- Change the batteries when a low battery warning is received. The ACCU-CAL™ 50-LED uses two AA-type batteries. The battery compartment is on the back of the instrument.

**Figure 19.**  
Battery Compartment (Closed & Open)



- Keep the detector head's sensing element clean and free of contaminants. The detector head may be cleaned with a clean tissue wetted with isopropyl alcohol.

## Spare Parts and Accessories

Item	Part Number
BlueWave QX4 Optic Adapter Upgrade Kit <i>Includes optometer calibration update</i>	42218
Adapter Kit – Flood to Spot Model (includes parts listed below)	39554
Line Array Adapter Upgrade Kit <i>Includes optometer firmware, calibration update, and Line Array Adapter</i>	43383
Lightguide Simulator	38408
8-mm Lightguide Adapter	39558
5-mm Lightguide Adapter	39557
3-mm Lightguide Adapter	39556
Line Array Adapter	43364
2-mm Hex Wrench	38656
2-mm Screws	38881

## Specifications

Property	Specification
Power	Two AA size batteries
Display	LCD Graphic Display 97x 32 Pixel Display area: 0.56 in x 1.41 in (14.3 mm x 35.8 mm)
Spectral Range	350-450 nm
Detector Interface	9-Pin MDSM9 socket, 4 inputs
Measurement Ranges	Four modes of operation Auto range within each operating mode
Front Panel Control	3 buttons
Temperature	Operating: 5 to 40°C Storage: -10 to 50° C
Size	5.71 in x 2.48 in x 1.18 in (145 mm x 63 mm x 30 mm)
Weight	0.33 lbs (150 g)



## Warranty

From date of purchase, Dymax Corporation offers a one-year warranty against defects in material and workmanship on all system components with proof of purchase date. Unauthorized repair, modification, or improper use of equipment may void your warranty benefits. The use of aftermarket replacement parts not supplied or approved by Dymax Corporation will void any effective warranties and may result in damage to the equipment.

***IMPORTANT NOTE: DYMAX CORPORATION RESERVES THE RIGHT TO INVALIDATE ANY WARRANTIES, EXPRESSED OR IMPLIED, DUE TO ANY REPAIRS PERFORMED OR ATTEMPTED ON DYMAX EQUIPMENT WITHOUT WRITTEN AUTHORIZATION FROM DYMAX. THOSE CORRECTIVE ACTIONS LISTED ABOVE ARE LIMITED TO THIS AUTHORIZATION.***







[www.dymax.com](http://www.dymax.com)

**Americas**

USA | +1.860.482.1010 | [info@dymax.com](mailto:info@dymax.com)

**Europe**

Germany | +49 611.962.7900 | [info\\_de@dymax.com](mailto:info_de@dymax.com)

Ireland | +353 21.237.3016 | [info\\_ie@dymax.com](mailto:info_ie@dymax.com)

**Asia**

Singapore | +65.67522887 | [info\\_ap@dymax.com](mailto:info_ap@dymax.com)

Shanghai | +86.21.37285759 | [dymaxasia@dymax.com](mailto:dymaxasia@dymax.com)

Shenzhen | +86.755.83485759 | [dymaxasia@dymax.com](mailto:dymaxasia@dymax.com)

Hong Kong | +852.2460.7038 | [dymaxasia@dymax.com](mailto:dymaxasia@dymax.com)

Korea | +82.31.608.3434 | [info\\_kr@dymax.com](mailto:info_kr@dymax.com)

© 2019-2021 Dymax Corporation. All rights reserved. All trademarks in this guide, except where noted, are the property of, or used under license by Dymax Corporation, U.S.A.

The data contained in this bulletin is of a general nature and is based on laboratory test conditions. Dymax Europe GmbH does not warrant the data contained in this bulletin. Any warranty applicable to products, its application and use is strictly limited to that contained in Dymax Europe GmbH's General Terms and Conditions of Sale published on our website. Dymax Europe GmbH does not assume any responsibility for test or performance results obtained by users. It is the user's responsibility to determine the suitability for the product application and purposes and the suitability for use in the user's intended manufacturing apparatus and methods. The user should adopt such precautions and use guidelines as may be reasonably advisable or necessary for the protection of property and persons. Nothing in this bulletin shall act as a representation that the product use or application will not infringe a patent owned by someone other than Dymax Corporation or act as a grant of license under any Dymax Corporation Patent. Dymax Europe GmbH recommends that each user adequately test its proposed use and application of the products before actual repetitive use, using the data contained in this bulletin as a general guide.

PN40506 MAN002EU 3/14/2019