

# Dymax ACCU-CAL™ 50-LED User Guide

## LED Radiometer

- Instructions for Safe Use
- Setup and Operation
- Maintenance
- Ordering Spare Parts and Accessories



ACCU-CAL™ 50-LED (PN 40519)



ACCU-CAL™ 50-LED with Adapter Kit (PN 40505)

### **About Dymax**

#### **UV/Visible light-curable adhesives. Systems for light curing, fluid dispensing, and fluid packaging.**

Dymax manufactures light-curable adhesives as well as a complete line of manual fluid dispensing systems, automatic fluid dispensing systems, and light-curing systems. Light-curing systems include LED light sources, spot, flood, and conveyor systems designed for compatibility and high performance with Dymax adhesives.

Dymax adhesives and light-curing systems optimize the speed of automated assembly, allow for 100% in-line inspection, and increase throughput. System designs enable stand-alone configuration or integration into your existing assembly line.

Please note that most dispensing and curing system applications are unique. Dymax does not warrant the fitness of the product for the intended application. Any warranty applicable to the product, its application and use is strictly limited to that contained in the Dymax standard Conditions of Sale. Dymax recommends that any intended application be evaluated and tested by the user to insure that desired performance criteria are satisfied. Dymax is willing to assist users in their performance testing and evaluation by offering equipment trial rental and leasing programs to assist in such testing and evaluations. Data sheets are available for valve controllers or pressure pots upon request.

# Contents

<b>Introduction</b> .....	<b>4</b>
General Safety .....	5
Safety.....	5
Sécurité .....	5
Sicherheitshinweise.....	6
<b>Product Overview</b> .....	<b>6</b>
Description of the ACCU-CAL™ 50-LED Radiometer.....	6
<b>Installation</b> .....	<b>7</b>
Unpacking and Inspecting Your Shipment.....	7
Parts Included for Spot & Line array Configuration.....	8
Parts Included for Flood Configuration .....	8
<b>Operation</b> .....	<b>9</b>
Testing a Flood Lamp System .....	9
Testing Spot Lamp Systems .....	10
Testing a Line Array System.....	12
Testing the BlueWave® QX4™ .....	15
<b>Maintenance</b> .....	<b>17</b>
<b>Spare Parts and Accessories</b> .....	<b>18</b>
Spare Parts .....	18
<b>Specifications</b> .....	<b>18</b>

# Introduction

The enclosed ACCU-CAL™ 50-LED Radiometer was developed and manufactured by the Dymax team, driven by a desire to best serve your needs. Before shipping, your ACCU-CAL™ 50-LED Radiometer was calibrated and tested against standard LED light sources to ensure accurate performance.

The operation of this radiometer in conjunction with an LED light-curing system will maximize safety and user-friendly performance and provide optimum yield of your technological process.

Therefore, we encourage you to read, understand, and follow all safety and operating instructions and recommendations compiled in this and other related manuals prior to setting up and operating this instrument and any associated light-curing systems.

If you encounter a problem, have any questions, or would like to help us with your suggestions or recommendations, please contact our Technical or Customer Service Departments at 860-482-1010. Trained Dymax professionals are standing by to serve you.

Par conséquent, nous vous encouragez à lire, comprendre, et suivre toute sécurité et instructions d'opération et recommandations rédigées dans cette et autres manuels établis un lien avant de mettre en place et de faire fonctionner ce nouveau système de lampe de tâche ou ces composants individuels.

Si vous rencontrez un problème, avez n'importe de questions, ou si vous voudrez de nous aider avec vos suggestions ou recommandations, s'il vous plaît contactez notre département technique ou service client à 860-482-1010. Dymax formé professionnels attendent de vous servir.

# Safety

## General Safety

Before continuing, please read the following chapters of this manual for safety recommendations and installation, running, and troubleshooting instructions.



**CAUTION!** Always wear protective goggles or a face shield when working near the front of any unit which emits UV light! The rear of some units also emits stray UV light.

**WARNING!** Always observe safety requirements!

**PRÉ-CAUTION!** Toujours faire de l'usage des lunettes de protection ou protéger de visage marche près du devant d'élément!

**PRÉ-CAUTION!** Risque de décharge électrique quand le couvert est enlever!

**ACHTUNG!** Tragen Sie immer eine Sicherheitsbrille oder einen Gesichtsschutz, wenn Sie nahe an der UV Lichtquelle arbeiten. Die Rückseite des Gerätes emittiert gestreutes UV Licht!

**WARNHINWEIS!** Bitte beachten Sie immer die Sicherheitshinweise!

## Safety

The ACCU-CAL™ 50-LED Radiometer is designed to be used in conjunction with Dymax LED curing equipment that is properly set up, with components correctly connected, and operated in accordance with relevant instructions.

### Safety Recommendations

- When working with UV or visible light sources, use goggles (provided) or a face shield approved for UV protection to protect your eyes.
- Long-sleeved shirts or a lab coat are recommended to protect the arms, and use of UV opaque gloves will protect the hands.

## Sécurité

L'équipement être conçu pour être utilisé correctement constituer, avec composants brancher correctement, et marché en conformément avec instructions important. Le plan états développer pour rendre au maxime opérateur sécurité et minimiser exposition à ultraviolette.

### Recommander de sécurité

- Emploi lunettes, ou un protéger de visage pour protection de ultraviolet pour protéger vous yeux.
- Chemises à manche long, ou manteau de labo, sont recommander pour protéger les bras, et utilisation de ultraviolette gants opaque vais protéger les mains.

## Sicherheitshinweise

Dieses Gerät wurde so entwickelt, dass es nur vollständig, alle Komponenten korrekt miteinander verbunden, in Übereinstimmung mit relevanten Instruktionen betrieben wird. Bei der Entwicklung wurde weiterhin großen Wert auf die Benutzersicherheit und minimale UV Belastung gelegt.

### Sicherheitshinweise

- Tragen Sie immer die mitgelieferten Sicherheitsbrille oder speziellen Gesichtsschutz, der Ihre Augen vor UV Licht schützt.
- Wir empfehlen Langarm - Hemden oder einen Laborkittel zu tragen, um die Arme zu schützen. Für die Hände empfehlen wir UV- geblockte Handschuhe.

BITTE BEACHTEN SIE: Durch den installierten inneren Filter strahlt die BlueWave® LED Prime UVA und sichtbares Licht aus. Schauen Sie deshalb niemals direkt in die Lichtquelle, wenn das Gerät angeschaltet ist.

# Product Overview

## Description of the ACCU-CAL™ 50-LED Radiometer

The ACCU-CAL™ 50-LED Radiometer is a microprocessor-based measurement instrument designed to measure curing-energy radiation in the range of 350 - 450 nm.

The ACCU-CAL™ 50-LED uses two AA batteries.

### Environmental Considerations

- Optical measurement instruments are sensitive to extremes in environmental conditions like high temperature, humidity, and contamination. Protect the device and its detector(s) from high humidity, high temperature, direct sunlight, and contamination.
- Do not use the ACCU-CAL™ 50-LED Radiometer immediately after moving it from a cold to a warm environment. Under certain circumstances, condensation could develop that may cause inaccurate measurement results. Allow the device to adjust to room temperature before use.
- Do not use the ACCU-CAL™ 50-LED Radiometer in powerful magnetic, electromagnetic, or electrostatic fields. These disturbances may influence measurement results.

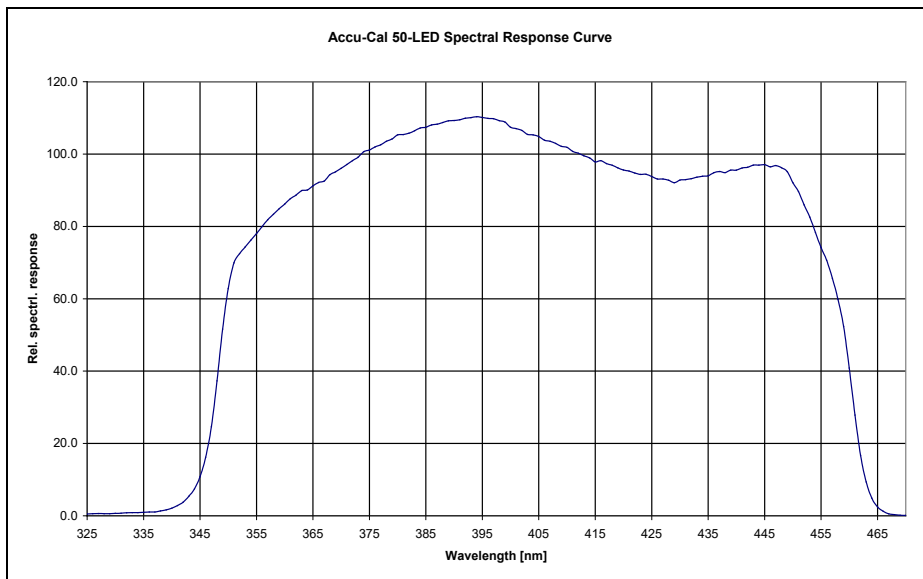
**Figure 1. ACCU-CAL™ 50-LED Spectral Response Curve**

# Installation

## Unpacking and Inspecting Your Shipment

When your radiometer arrives, inspect the box and immediately notify the shipper of any damage.

Open the box and check for equipment damage. If parts are damaged, notify the shipper and submit a claim for the damaged parts. Contact Dymax so that new parts can be shipped to you immediately.

Check that the parts included in your order match those listed below. If parts are missing, contact your local Dymax representative or Dymax Customer Support to resolve the problem.

**Figure 2. ACCU-CAL™ 50-LED Radiometer (PN 40505) for Spot, Line, & Flood Lamps**



### Parts Included for Spot & Line Array Configuration

- ACCU-CAL 50-LED Radiometer
- ACCU-CAL 50-LED Radiometer User Guide
- 3-mm, 5-mm, 8-mm Lightguide Adapters
- Optic Adapter for the BlueWave® QX4™
- Line-Array Adapter
- Lightguide Simulator (PN 38408)
- 2-mm Hex Wrench
- Spare 2-mm Adapter Screws

**Figure 3. ACCU-CAL™ 50-LED Radiometer (PN 40519) for Flood Lamps Only**



### Parts Included for Flood Configuration

- ACCU-CAL 50-LED Radiometer
- ACCU-CAL 50-LED Radiometer User Guide



# Operation

The ACCU-CAL™ 50-LED Radiometer may be used to measure intensity from LED-type flood, line array, or spot sources. Instructions for use with each system type are below.

## Testing a Flood Lamp System

1. Attach the detector to the radiometer (Figure 4). Do not attach any lightguide adapters to the detector.
2. Press and release the On/Off button on the radiometer's face plate to turn the unit on.
3. On the radiometer's display, the top line displays the light source and the second line displays the mode.
4. Press and release the Light Source button to select the light source being measured. Repeatedly press the button until "Flood Lamp" appears on the top line of the display (Figure 5).

**Figure 4. Attach Detector to Radiometer**



**Figure 5. Flood Source Screen (Shown in Peak Intensity Mode)**

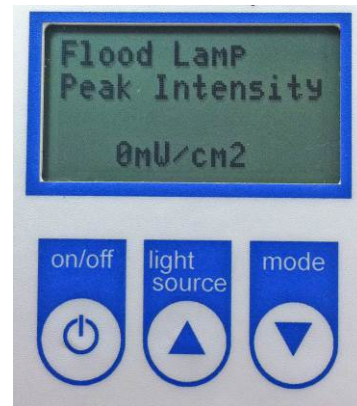

5. Press and release the Mode button to select the operating mode. Repeatedly press the Mode button until the mode you desire appears on the second line of the display. The different operating modes are:
  - **Peak Intensity** - Shows the highest intensity in  $\text{mW}/\text{cm}^2$  seen by the detector during the measurement and stores that value in the display.
  - **Intensity** - Shows the intensity in  $\text{mW}/\text{cm}^2$  at the detector during the measurement. This is a dynamic readout of intensity.
  - **Dose** - Shows the total energy dose in  $\text{mJ}/\text{cm}^2$  at the detector during the measurement.  
*Note: This measurement is time dependent.*
6. Place the end of the Detector under an operating flood lamp, insuring that the detector sensing window is facing the light source.

## Testing Spot Lamp Systems

1. Attach the detector to the radiometer (Figure 6).
2. Select the lightguide adapter that matches the size of the spot lamp's lightguide. 3, 5, and 8-mm lightguide adapters are supplied with the radiometer.
3. Install the lightguide adapter on the end of the detector using the two 2-mm adapter screws provided (Figure 7).

**Figure 6. Attach Detector**



**Figure 7. Adapter Installation**

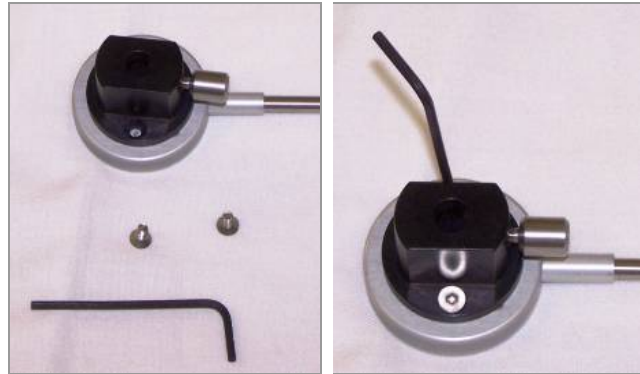

4. Insert the lightguide into the lightguide adapter until it bottoms out. Tighten the set screw when the lightguide is installed.

*Note: Do not over-tighten the set screw, as damage to the lightguide may occur.*

**Figure 8. Attach Lightguide Adapter to Lightguide**

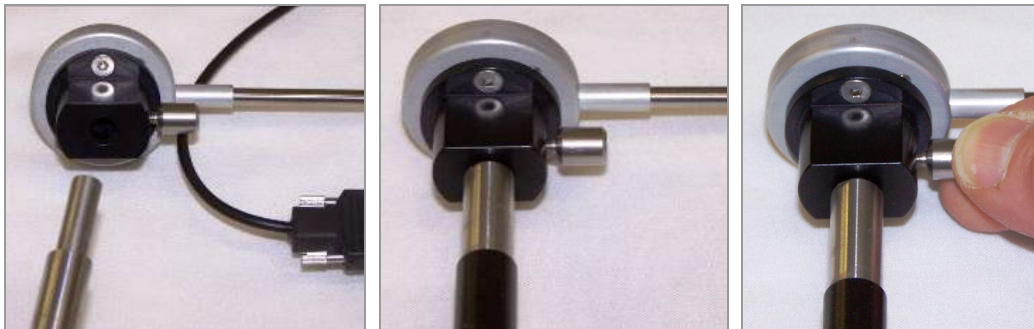

7. Press and release the On/Off button on the radiometer's face plate to turn the unit on.
8. On the radiometer's display, the top line displays the light source and the second line displays the mode.
9. Press and release the Light Source button to select the light source being measured. For spot lamps, use the lightguide setting. Repeatedly press the Light Source button until the correct lightguide size appears on the top line. The options are:

- **3-mm Lightguide** - For use when measuring energy at the end of a 3-mm lightguide.
- **5-mm Lightguide** - For use when measuring energy at the end of a 5-mm lightguide.
- **8-mm Lightguide** - For use when measuring energy at the end of an 8-mm lightguide.

**Figure 9. Lightguide Source Screens (Shown in Peak Intensity Mode)**



10. Press and release the Mode button to select the operating mode. Repeatedly press the Mode button until the mode you desire appears on the second line of the display. The different operating modes are:
  - **Peak Intensity** - Shows the highest intensity in  $\text{mW}/\text{cm}^2$  seen by the detector during the measurement and stores that value in the display.
  - **Intensity** - Shows the intensity in  $\text{mW}/\text{cm}^2$  at the detector during the measurement. This is a dynamic readout of intensity.
  - **Dose** - Shows the total energy dose in  $\text{mJ}/\text{cm}^2$  at the detector during the measurement.  
*Note: This measurement is time dependent.*
11. Turn on the spot lamp to begin testing.

## Testing a Line Array System

1. Attach the detector to the radiometer (Figure 11).
2. Select the line array adapter.

**Figure 10. Line Array Adapter**



3. Install the line array adapter onto the detector face using the two 2-mm screws provided (Figure 12).

**Figure 11. Attach Detector**



**Figure 12. Adapter Installation**

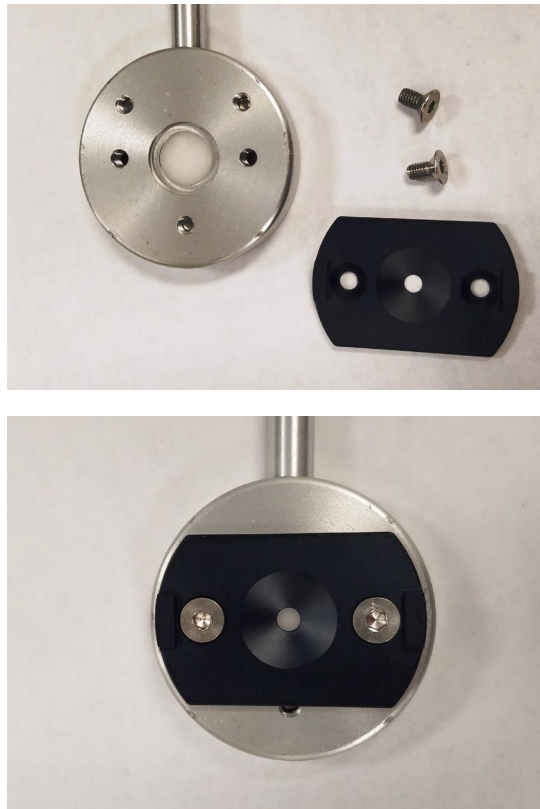

*Note: Do not over-tighten the set screw, as damage to the lightguide may occur.*

4. Press and release the On/Off button on the radiometer's face plate to turn the unit on.
5. On the radiometer's display, the top line displays the light source and the second line displays the mode.

- Repeatedly press and release the Light Source button until “Line Array” is displayed in the top line of the display.

**Figure 13. Line Array Source Screen (Shown in Intensity Mode)**

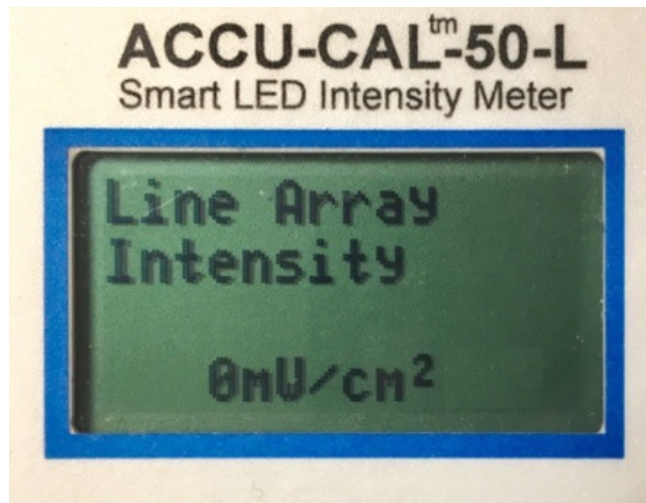

6. Press and release the Mode button to select the operating mode. Repeatedly press the Mode button until the mode you desire appears on the second line of the display. The different operating modes are:

- **Peak Intensity** - Shows the highest intensity in  $\text{mW}/\text{cm}^2$  seen by the detector during the measurement and stores that value in the display.
- **Intensity** - Shows the intensity in  $\text{mW}/\text{cm}^2$  at the detector during the measurement. This is a dynamic readout of intensity.
- **Dose** - Shows the total energy dose in  $\text{mJ}/\text{cm}^2$  at the detector during the measurement.  
*Note: This measurement is time dependent.*

7. Taking measurements

- Static readings for general process control when emitter and target are fixed and working distances are greater than 0 mm:
  1. Using a fixed location in the field of the array emissions, place the aperture of the adapter as close to center as allowable.
 

NOTE: Repeatable placement is key to getting consistent readings at working distances beyond direct measurement at the emitter face. An alignment fixture can help ensure accuracy at these working distances.
  2. Select the measurement mode appropriate for the data required and take readings. To improve accuracy, it is suggested that multiple measurements be taken and averaged.
- Direct readings at 0 mm working distance for repeatable measurements:

1. With the adapter installed, align the radiometer sensor by nesting the emitter faceplate onto the adapter tabs to ensure precise engagement.

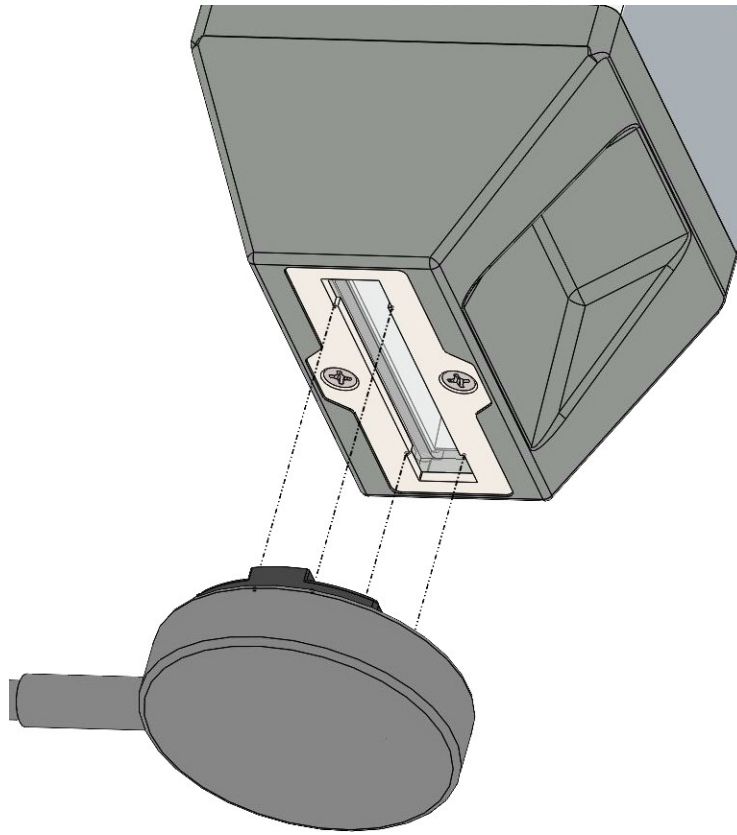

**Figure 14. Adapter Alignment**

2. Keep the sensor and emitter square to each other and activate an exposure cycle of the emitter.
3. Take intensity reading after 5-10 seconds to allow for output stabilization.
4. To avoid possible damage to the radiometer sensor, allow the sensor to cool between measurements and do not expose the sensor to energy emissions for more than 15 seconds.



## Testing the BlueWave® QX4™

1. Attach the detector to the radiometer (Figure 15).
2. Attach the BlueWave® QX4™ Optic Adapter to the detector (Figure 16) using the two 2-mm screws provided.

*Note: The Optical Adapter and Optometer are calibrated as a set, so they are not interchangeable among other similar type radiometers.*

**Figure 15. Attach Detector**



**Figure 16. Attach Optic Adapter to Detector**



3. Insert the LED Wand into the Optic Adapter until it bottoms out. Tighten the set screw on the top of the Optic Adapter when the LED Wand is installed.

*Note: Do not over-tighten the set screw, as damage to the LED wand may occur.*

**Figure 17. Insert LED Wand into Optical Adapter**



4. Press and release the On/Off button on the radiometer's face plate to turn the unit on.
5. On the radiometer's display, the top line displays the light source and the second line displays the mode.
6. Press and release the Light Source button to select the light source being measured. For the BlueWave® QX4™, use the "spot" setting. Repeatedly press the Light Source button until the correct focus lens size appears on the top line. The options are:

- **3-mm Spot** - For use when measuring a BlueWave® QX4™ Wand with the 3-mm Focus Lens installed
- **5-mm Spot** - For use when measuring a BlueWave® QX4™ Wand with the 5-mm Focus Lens installed
- **8-mm Spot** - For use when measuring a BlueWave® QX4™ Wand with the 8-mm Focus Lens installed

**Figure 18. Spot Mode Screens (Shown in Peak Intensity Mode)**



7. Press and release the Mode button to select the operating mode. The different operating modes are:
  - **Peak Intensity** - Shows the highest intensity in  $\text{mW}/\text{cm}^2$  seen by the detector during the measurement and stores that value in the display.
  - **Intensity** - Shows the intensity in  $\text{mW}/\text{cm}^2$  at the detector during the measurement. This is a dynamic readout of intensity.
  - **Dose** - Shows the total energy dose in  $\text{mJ}/\text{cm}^2$  at the detector during the measurement.  
*Note: This measurement is time dependent.*
8. Turn on the BlueWave® QX4™ to begin testing.



# Maintenance

The ACCU-CAL™ 50-LED was designed to operate with minimum maintenance. Follow the schedule below to assure top unit performance.

- Calibrate the instrument at least annually. Calibration service is available through Dymax Customer Service or Dymax Product Repair.
- Change the batteries when a low battery warning is received. The ACCU-CAL™ 50-LED uses two AA-type batteries. The battery compartment is on the back of the instrument.

**Figure 19. Battery Compartment (Closed & Open)**



- Keep the detector head's sensing element clean and free of contaminants. The detector head may be cleaned with a clean tissue wetted with isopropyl alcohol.

# Spare Parts and Accessories

## Spare Parts

Item	Part Number
BlueWave® QX4™ Optic Adapter Upgrade Kit (includes optometer calibration update)	42218
Adapter Kit – Flood to Spot Model (includes parts listed below)	39554
Line Array Adapter Upgrade Kit (Includes optometer firmware, calibration update, and Line Array Adapter)	43383
Lightguide Simulator	38408
8-mm Lightguide Adapter	39558
5-mm Lightguide Adapter	39557
3-mm Lightguide Adapter	39556
Line Array Adapter	43364
2 mm Hex Wrench	38656
2 mm Screws	38881

## Specifications

Property	Specification
<b>Power</b>	Two AA size batteries
<b>Display</b>	LCD Graphic Display 97x 32 Pixel Display area: 0.56 in x 1.41 in (14.3 mm x 35.8 mm)
<b>Spectral Range</b>	350-450 nm
<b>Detector Interface</b>	9-Pin MDSM9 socket, 4 inputs
<b>Measurement Ranges</b>	Four modes of operation Auto range within each operating mode
<b>Front Panel Control</b>	3 buttons
<b>Temperature</b>	Operating: 5 to 40°C Storage: -10 to 50° C
<b>Size</b>	5.71 in x 2.48 in x 1.18 in (145 mm x 63 mm x 30 mm)
<b>Weight</b>	0.33 lbs (150 g)



# Warranty

From date of purchase, Dymax Corporation offers a one-year warranty against defects in material and workmanship on all system components with proof of purchase date. Unauthorized repair, modification, or improper use of equipment may void your warranty benefits. The use of aftermarket replacement parts not supplied or approved by Dymax Corporation will void any effective warranties and may result in damage to the equipment.

***IMPORTANT NOTE:*** DYNAMX CORPORATION RESERVES THE RIGHT TO INVALIDATE ANY WARRANTIES, EXPRESSED OR IMPLIED, DUE TO ANY REPAIRS PERFORMED OR ATTEMPTED ON DYNAMX EQUIPMENT WITHOUT WRITTEN AUTHORIZATION FROM DYNAMX. THOSE CORRECTIVE ACTIONS LISTED ABOVE ARE LIMITED TO THIS AUTHORIZATION.



© 2019 Dymax Corporation. All rights reserved. All trademarks in this guide, except where noted, are the property of, or used under license by Dymax Corporation, U.S.A.

Please note that most dispensing system applications are unique. Dymax does not warrant the fitness of the product for the intended application. Any warranty applicable to the product, its application and use is strictly limited to that contained in Dymax standard Conditions of Sale published on our website. Dymax recommends that any intended application be evaluated and tested by the user to ensure that desired performance criteria are satisfied. Dymax is willing to assist users in their performance testing and evaluation. Data sheets are available for valve controllers or pressure pots upon request.

MAN002DA 3/14/2019

**Dymax Corporation**  
+1.860.482.1010 | info@dymax.com | [www.dymax.com](http://www.dymax.com)

**Dymax Europe GmbH**  
+49 (0) 611.962.7900 | info\_de@dymax.com | [www.dymax.de](http://www.dymax.de)

**Dymax Engineering Adhesives Ireland Ltd.**  
+353 21.237.3016 | info\_ie@dymax.com | [www.dymax.ie](http://www.dymax.ie)

**Dymax Oligomers & Coatings**  
+1.860.626.7006 | info\_oc@dymax.com | [www.dymax-oc.com](http://www.dymax-oc.com)

**Dymax UV Adhesives & Equipment (Shanghai) Co. Ltd.**  
+86.21.37285759 | dymaxasia@dymax.com | [www.dymax.com.cn](http://www.dymax.com.cn)

**Dymax UV Adhesives & Equipment (Shenzhen) Co. Ltd.**  
+86.755.83485759 | dymaxasia@dymax.com | [www.dymax.com.cn](http://www.dymax.com.cn)

**Dymax Asia (H.K.) Limited**  
+852.2460.7038 | dymaxasia@dymax.com | [www.dymax.com.cn](http://www.dymax.com.cn)

**Dymax Asia Pacific Pte. Ltd.**  
+65.6752.2887 | info\_ap@dymax.com | [www.dymax-ap.com](http://www.dymax-ap.com)

**Dymax Korea LLC**  
+82.2.784.3434 | info\_kr@dymax.com | [www.dymax.com/kr](http://www.dymax.com/kr)